

operating instructions and spare parts

GLW 502



Carl Cloos Schweisstechnik GmbH

Industriestrasse

35708 Haiger

Germany

Telefon (0 27 73) 85-0

Telefax (0 27 73) 85-275

E-Mail: info@cloos.de

Internet: <http://www.cloos.de>

RW - FP - Rev.0

Ausgabedatum 3. 02 2015

Keep for further use.

CARL CLOOS Schweißtechnik GmbH
Industriestrasse
35708 Haiger
Tel. (+49) 2773/85-0
Fax. (+49) 2773/85-275
mail: info@cloos.de
www.cloos.de



Document: QIGLW502

Month/Year: 01/14

**EC-Declaration of Conformity
in accordance with EC Directives 2006/95/EG (low voltage) and 2004/108/EG (EMV)**

We herewith certify that the welding machine mentioned below has been developed, designed and manufactured in accordance with the EC Directives and brought on the market.

Designation of the machine: TIG welding machine
Type: QINEO GLW 502
Serial number: see type plate (on the rear of the machine)

The following EC Directives have been applied:

- EC Low voltage directives (2006/95/EG)
- EC Directives on Electromagnetic compatibility (2004/108/EG)
- EC Directives RoHS (2011/65/EU)

The following harmonised standards have been applied:

- EN 60974-1 Arc welding equipment
Part 1: Welding power sources
- EN 60974-3 Arc welding equipment
Teil 3: Arc striking and stabilizing devices
- EN 60974-10 Arc welding equipment
Part 10: Electromagnetic compatibility (EMC) requirements

Any significant modifications or extensions on the machine which are not carried out by the above manufacturer or his authorised representative will invalidate this Declaration of Conformity.

Manufacturer's signature:
Information on the signatory:



Gerald Mies
Managing Director

CONTENTS

1	INTRODUCTION	5
2	INSTALLATION	6
2.1	CONNECTIONS TO THE ELECTRICAL MAINS NETWORK	6
2.2	FRONT PANEL	6
2.3	REAR PANEL	6
2.4	PREPARING FOR MMA WELDING	7
2.5	PREPARING FOR TIG WELDING	9
3	COMMISSIONING	11
3.1	USER INTERFACE	11
3.2	UNIT POWER-UP	14
3.3	RESET (LOAD FACTORY SETTINGS)	14
3.3.1	PARTIAL RESET	14
3.3.2	TOTAL RESET	14
3.4	SET-UP (INITIAL SET-UP OF THE WELDING POWER SOURCE)	15
3.5	ALARMS MANAGEMENT	17
4	WELDING SETTINGS	19
4.1	TORCH TRIGGER PROCEDURE	19
4.2	SELECTION OF THE WELDING MODE AND TORCH TRIGGER PROCEDURE	22
4.3	WELDING PARAMETERS	23
4.4	PARAMETERS ACTIVATION	26
4.5	PARAMETERS SETTING: (1ST LEVEL)	28
4.6	PARAMETERS SETTING: (2ND LEVEL)	30
4.7	PARAMETERS SETTING: SPECIAL FUNCTIONS	31
4.8	JOBS MANAGEMENT	32
4.8.1	SAVING A JOB	32
4.8.2	LOADING A USER JOB OF FACTORY SET JOB	32
4.8.3	DELETING A JOB	32
4.8.4	SELECTING A JOB WITH THE TORCH BUTTON	33
5	TECHNICAL DATA	34
5.1	GLW 502	34
6	SPARE PARTS	36
6.1	GLW 502	36
7	ELECTRICAL DIAGRAM	38
7.1	GLW 502	38
7.2	CONNECTOR FOR "REMOTE1"	43
7.3	CONNECTOR FOR "REMOTE2"	43
7.4	TORCH CONNECTOR	45
7.5	REMOTE CONTROLLER CONNECTOR	45

1 INTRODUCTION



IMPORTANT!

This handbook must be consigned to the user prior to installation and commissioning of the unit.
Read the "General prescriptions for use" handbook supplied separately from this handbook before installing and commissioning the unit.
The meaning of the symbols in this manual and the associated precautionary information are given in the "General prescriptions for use".
If the "General prescriptions for use" are not present, it is mandatory to request a replacement copy from the manufacturer or from your dealer.
Retain these documents for future consultation.

KEY



DANGER!

This pictogram warns of danger of death or serious injury.



WARNING!

This pictogram warns of a risk of injury or damage to property.



CAUTION!

This pictogram warns of a potentially hazardous situation.



INFORMATION

This pictogram gives important information concerning the execution of the relevant operations.

⊖ This symbol identifies an action that occurs automatically as a result of a previous action.

ⓘ This symbol identifies additional information or a reference to a different section of the manual containing the associated information.

§ This symbol identifies a reference to a chapter of the manual.

*1 The symbol refers to the associated numbered note.

NOTES

The figures in this manual are purely guideline and the images may contain differences with respect to the actual equipment to which they refer.

INTRODUCTION

This professional and rugged welding power source for DC MMA and TIG welding with exceptional arc characteristics is designed to operate in harsh environmental conditions in the fields of professional maintenance, shipyards and offshore, building construction and heavy fabrication.

The ARC AIR function allows perfect deseaming with carbon electrodes of up to 10 mm in diameter.

Up to 6 mm diameter electrode welding is possible in MMA.

In MMA welding the Hot Start and Arc Force functions are adjustable and they allow improved arc striking, a flatter bead and more uniform weld.

The Anti Sticking function makes it possible to detach the electrode rapidly from the workpiece in the event of accidental sticking.

The parameters preset in the DC TIG pulsed synergic curve simplify welding by regulation exclusively of the current.

The current is adjustable also from the Up-Down torch.

The simply and intuitive interface allows high precision adjustments with 50 storable programs.

The wide range of adjustable pulsed frequency in combination with the complementary parameters (base current and duty cycle) makes it possible to weld in slow and fast pulsed mode.

Thanks to its modular configuration, the power source can be configured out for MIG/MAG welding by adding a wire feed unit, extension, and, if required, a cooling unit and power source transport trolley.

Fan. The fan is turned on only during welding, at the end of the welding process it remains on for a fixed period of time according to welding conditions.

The fan is nonetheless controlled by specific thermal sensors that guarantee a correct cooling of the machine.

Accessories/ancillary devices that can be connected to the unit:

- UP/DOWN torch or torch with potentiometer to adjust the welding current from a distance.
- Manual remote controller for remote adjustment of the welding current.
- Foot-pedal remote controller for TIG torch arc striking and remote adjustment of welding current.

The maximum and minimum TIG welding current values can be set with the foot pedal controller.

ⓘ If both remote controllers are connected, the foot pedal assumes priority over the UP/DOWN or potentiometer TIG torch.

- Liquid cooler for TIG torches.
- Power source trolley.

Consult your dealer for an updated list of accessories and the latest available new products.

2 INSTALLATION

! DANGER!
Lifting and positioning

Read the warnings highlighted by the following symbols in the "General prescriptions for use".



2.1 CONNECTIONS TO THE ELECTRICAL MAINS NETWORK

The characteristics of the mains power supply to which the equipment shall be connected are given in the section entitled "Technical data" on page 34.

The machine can be connected to motorgenerators provided their voltage is stabilised.

Connect/disconnect the various devices with the machine switched off.

2.2 FRONT PANEL

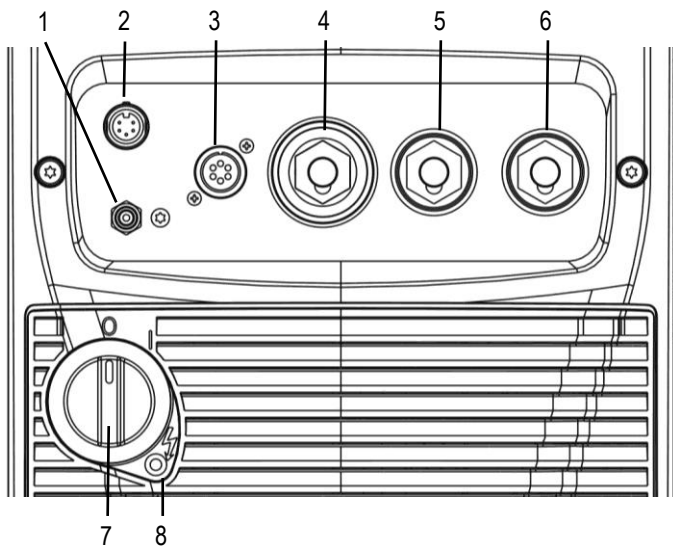

1. Connector for gas feed hose: power source → torch
2. Connector for logic signals of TIG torch.
3. Remote controller connector.
4. TIG TORCH welding socket.
5. Negative pole welding socket.
6. Positive pole welding socket.
7. Welding power source ON/OFF switch.
8. Mains protection ON LED.

This LED illuminates if an incorrect operating condition occurs:
- absence of a phase in the power supply line.

2.3 REAR PANEL

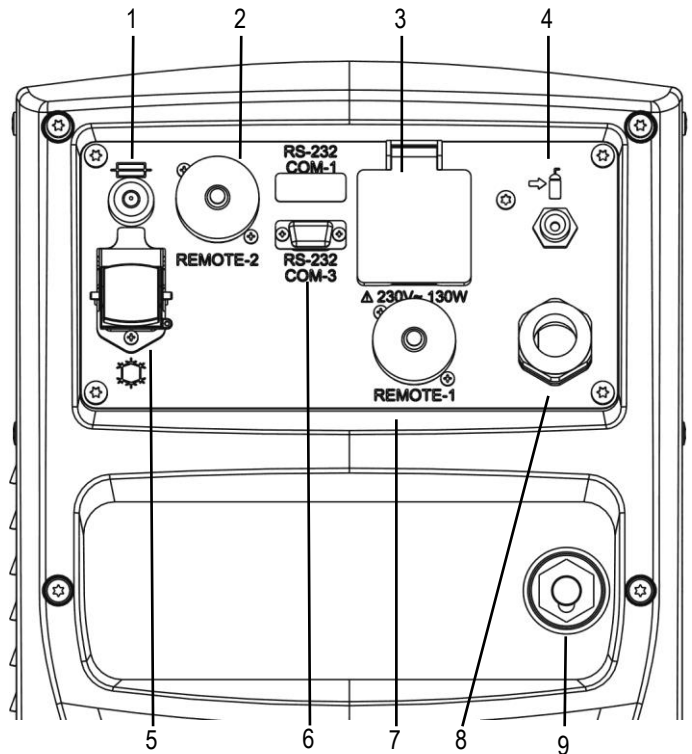

1. Power supply transformer fuse.
Type: Delayed acting (T)
Amperage: 2 A
Voltage: 500 V a.c.
2. Signals connector for automatic application.
3. Pre-heating unit power supply socket.
The socket is internally protected by a self-resetting fuse.
Power socket type: Schuko
Maximum power: 130 W
Voltage: 230 V a.c.
4. Connector for gas feed hose: cylinder → power source
5. Cooler power feeding connector.
Voltage: 400 V a.c.
Current output: 1.0 A
IP protection rating: IP20 (cap open) / IP66 (cap closed)

! DANGER!
High voltage!

If the socket is not connected to any devices always close the cap: presence of hazardous voltage levels!

6. Connector for connection to the programmer.
(Programming connector for the "frontal logic" circuit board)
You can update the software of the equipment using the programming kit.
7. Connector of the bundle of cables for connecting the power source to the remote control device.
8. Power cable.
Total length (including internal part): 5,0 m
- ① Number and cross section of wires: 4 x 2,5 mm²
Power plug type: not supplied
9. Socket for connecting the power cable between the power source and the remote control device.

2.4 PREPARING FOR MMA WELDING

1. Set the welding power source ON/OFF switch to "O" (unit de-energized).
2. Plug the power cable plug into a mains socket outlet.
3. Choose the electrode based on the type of material and thickness of the workpiece to be welded.
4. Insert the electrode in the electrode holder.
5. Connect the electrode holder cable to the welding socket based on the polarity requested by the type of electrode used.
6. Connect the plug of the ground clamp to the welding socket on the basis of the polarity required.
7. Connect the earth clamp to the workpiece being processed.

DANGER!
Electric shock hazard!

Read the warnings highlighted by the following symbols in the "General prescriptions for use".



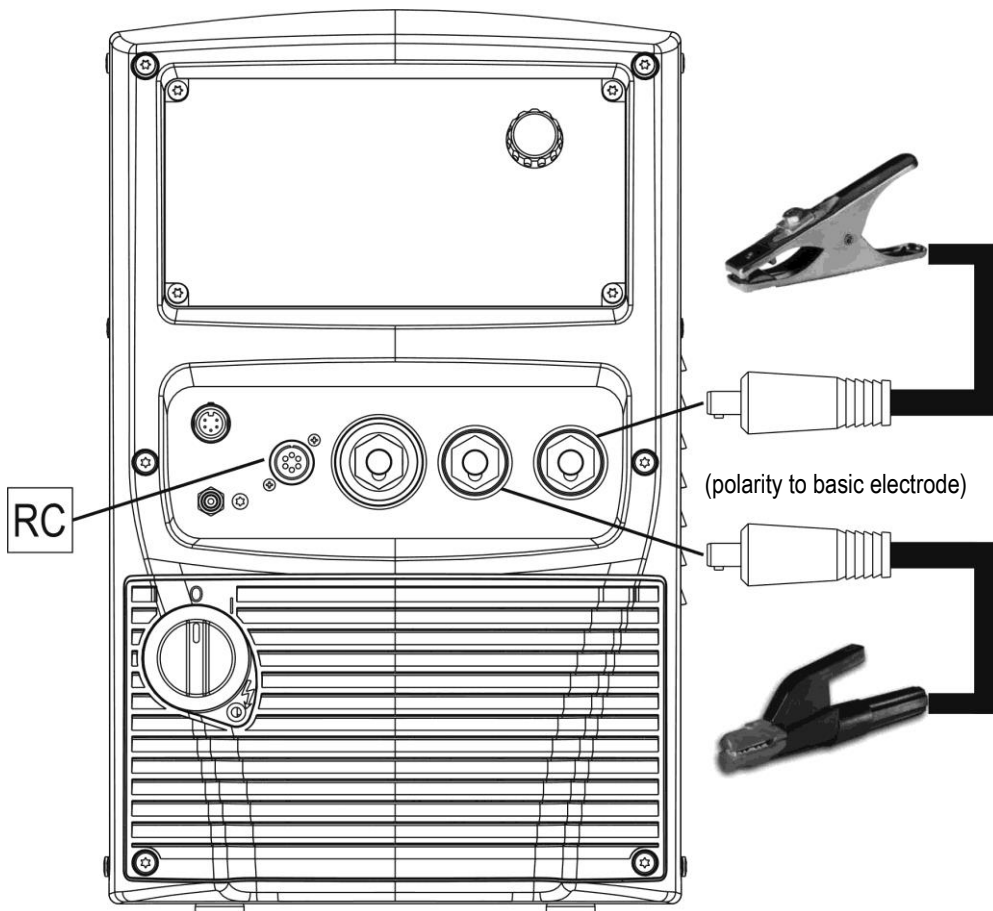
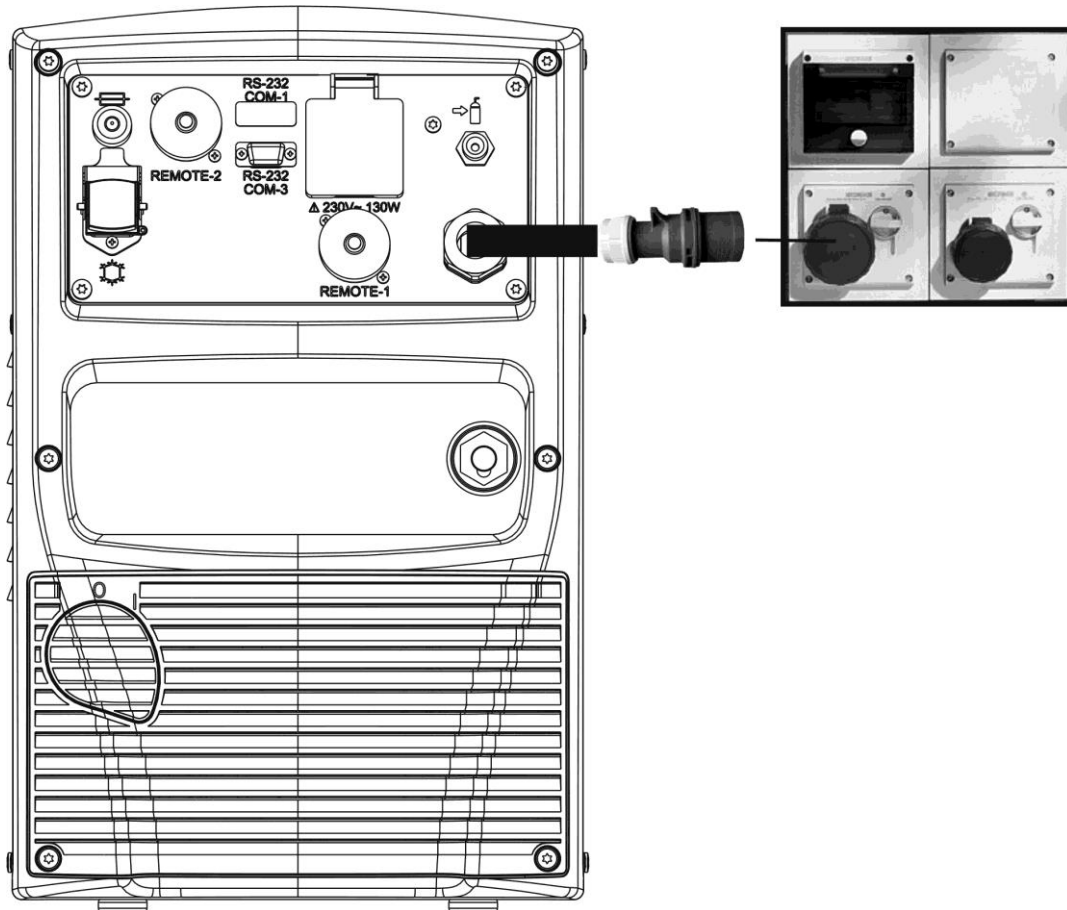

8. Set the welding power source ON/OFF switch to "I" (unit powered).
9. Select the following welding mode on the user interface: MMA
10. Set the required welding parameter values on the user interface.
- ① When the remote controller [RC] is connected and the relative locking screw is tightened, welding current can be adjusted using the remote controller.
The system is ready to start welding.



2.5 PREPARING FOR TIG WELDING

 NOTE: For the cooler to power source assembly procedure refer to the cooler instruction manual.

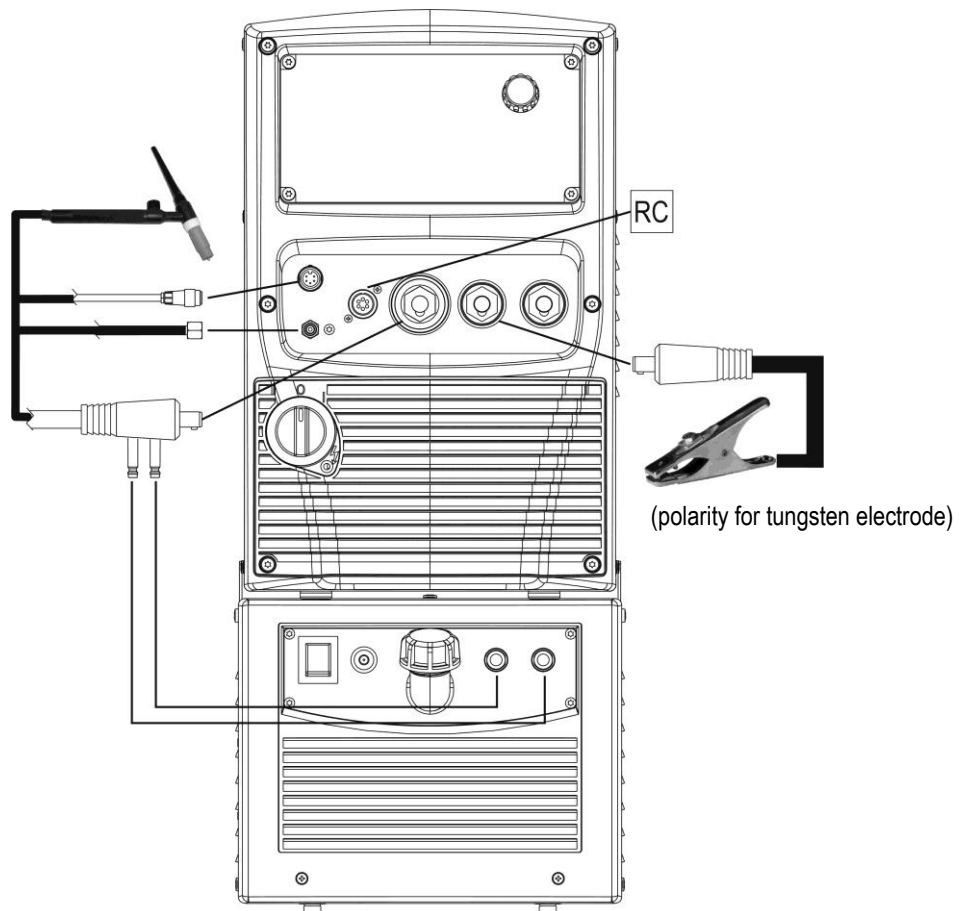
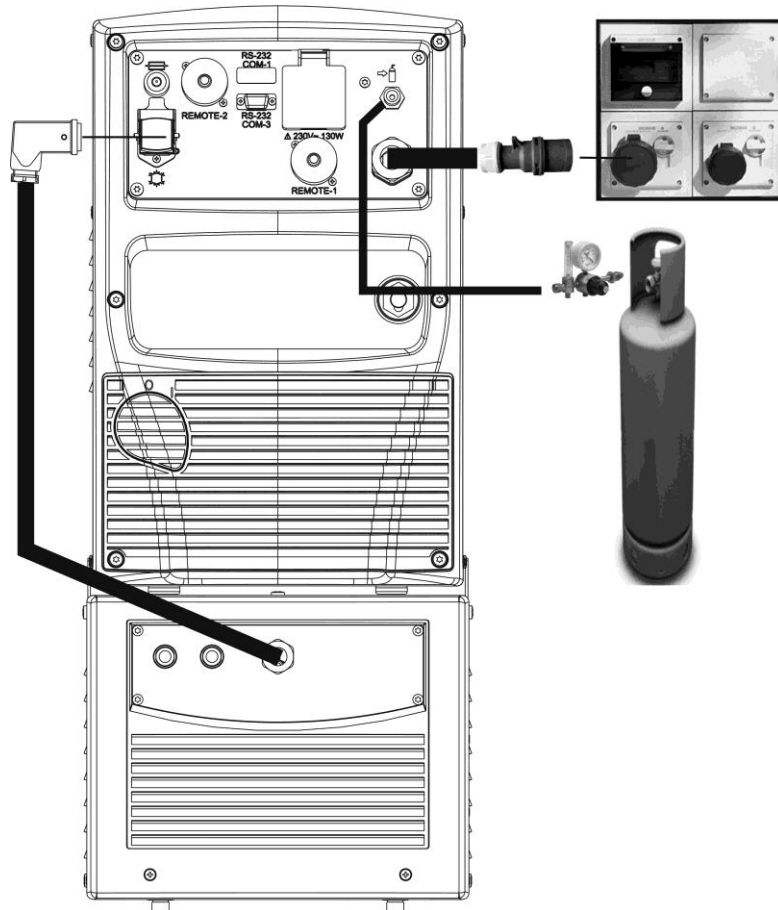
1. Set the welding power source ON/OFF switch to "O" (unit de-energized).
 2. Plug the power cable plug into a mains socket outlet.
 3. Connect the gas hose from the welding gas cylinder to the rear gas socket.
 4. Open the cylinder gas valve.
 5. Choose the electrode based on the type of material and thickness of the workpiece to be welded.
 6. Insert the electrode in the TIG torch.
 7. Connect the torch plug to the welding socket on the basis of the polarity required by the type of electrode in question.
 8. Connect the plug of the ground clamp to the welding socket on the basis of the polarity required.
 9. Connect the gas hose from the welding torch to the front gas socket.
 10. Couple the welding torch connector to the TIG torch signals connector.
 11. Connect the earth clamp to the workpiece being processed.
 12. Set the welding power source ON/OFF switch to "I" (unit powered).
 13. Select the following welding mode on the user interface: DC TIG
 14. Press the torch trigger with the torch well clear of any metal parts. This serves to open the gas solenoid valve without striking the welding arc.
 15. Use the flow control valve to adjust the flow of gas as required while the gas is flowing out.
 16. Set the required welding parameter values on the user interface.
-  When the remote control pedal is connected and the relative locking screw is tightened the welding current will vary in relation to the pressure exerted on the pedal.
- The system is ready to start welding.







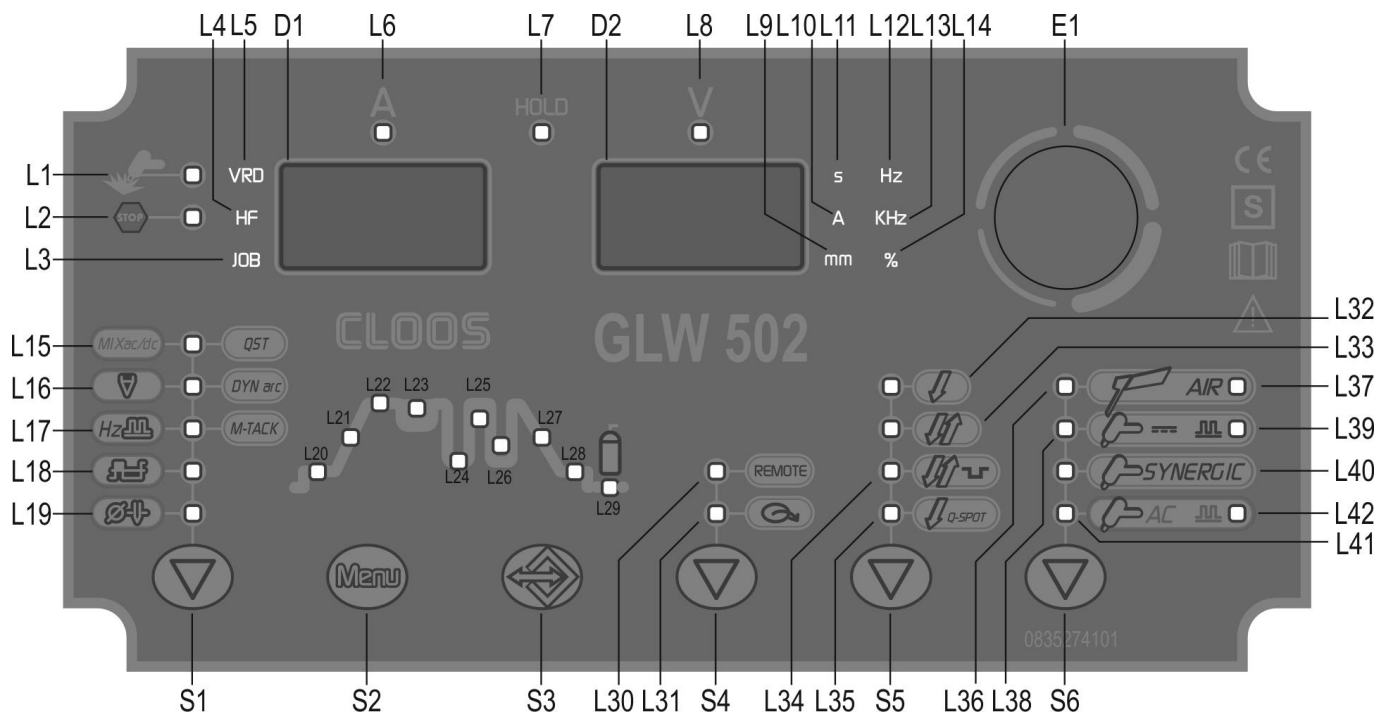

3 COMMISSIONING

3.1 USER INTERFACE



CODE	SYMBOL	DESCRIPTION
L1		This LED illuminates to confirm the presence of power on the output sockets.
L2		This LED illuminates to show an anomaly in the operating conditions. ① See § 3.5 ALARMS MANAGEMENT page 17.
L3	JOB	Illuminates to show that a previously saved JOB has been loaded.
L4	HF	Illumination shows that the following function has been activated: HIGH FREQUENCY ARC STRIKE (HF)
L5	VRD	Illumination shows that the following function has been activated: VRD (reduced output voltage). The no-load voltage between the welding sockets is switched from U_0 to U_r (see technical data).
L6	A	Illuminates to show a value in the following unit of measurement: AMPERES
L7	HOLD	Illuminates to show the last voltage and current values measured during welding. The value appears on the following displays: D1-D2 The LED switches off when a new welding procedure is started, or when any of the welding settings is modified.
L8	V	Illuminates to show a value in the following unit of measurement: VOLTS
L9	mm	Illuminates to show a value in the following unit of measurement: MILLIMETRES
L10	A	Illuminates to show a value in the following unit of measurement: AMPERES
L11	S	Illuminates to show a value in the following unit of measurement: SECONDS
L12	Hz	Illuminates to show a value in the following unit of measurement: HERTZ
L13	KHz	Illuminates to show a value in the following unit of measurement: KILOHERTZ
L14	%	Illuminates to show a value in the following unit of measurement: PERCENTAGE
L15	QST	DC TIG mode: When this LED illuminates the following parameter can be set: Q-START
L15	Mix ac/dc	AC TIG mode: When this LED illuminates the following parameter can be set: MIX AC/DC
L16	DYN arc	DC TIG mode: When this LED illuminates the following parameter can be set: DYNAMIC ARC
L16		AC TIG mode: When this LED illuminates the following parameter can be set: FUSIONE EXTRA
L17	M-TACK	DC TIG mode: When this LED illuminates the following parameter can be set: MULTI TACK
L17	Hz	AC TIG mode: When this LED illuminates the following parameter can be set: AC FREQUENCY
L18		AC TIG mode: When this LED illuminates the following parameter can be set: AC TIG BALANCE
L19		AC TIG mode: When this LED illuminates the following parameter can be set: ELECTRODE DIAMETER This LED flashes when the set welding current is too high in relation to the chosen electrode diameter.

CODE	SYMBOL	DESCRIPTION
L20		When this LED illuminates the following parameter can be set: STARTING CURRENT
L21		When this LED illuminates the following parameter can be set: SLOPE UP
L22		When this LED illuminates the following parameter can be set: WELDING CURRENT
L23		When this LED illuminates the following parameter can be set: SECOND CURRENT B-LEVEL
L24		When this LED illuminates the following parameter can be set: BASE CURRENT
L25		When this LED illuminates the following parameter can be set: PEAK TIME
L26+L27		When this LED illuminates the following parameter can be set: PULSED CURRENT FREQUENCY
L28		When this LED illuminates the following parameter can be set: BASE TIME
L29		When this LED illuminates the following parameter can be set: DOWN SLOPE
L30		When this LED illuminates the following parameter can be set: FINAL CURRENT
L31		When this LED illuminates the following parameter can be set: POST-GAS
L28	REMOTE	Illuminates to signal activation of a connected remote control unit, if available.
L29		This LED indicates that the current reference setting is imposed by the remote controller.
L30		Illumination shows that the following function has been activated: 2 stroke procedure.
L31		Illumination shows that the following function has been activated: 4 stroke procedure.
L32		Illumination shows that the following function has been activated: 4 stroke B-level procedure + high frequency arc strike (HF).
L33		Illumination shows that the following function has been activated: 2 stroke spot procedure (Q-SPOT).
L34		This LED illuminates to show that the following welding mode is selected: MMA
L35		This LED illuminates to show that the following welding mode is selected: DESEAMING MODE
L36		This LED illuminates to show that the following welding mode is selected: TIG DC CONTINUOUS
L37		This LED illuminates to show that the following welding mode is selected: PULSED DC TIG
L38		This LED illuminates to show that the following welding mode is selected: SYNERGIC PULSED DC TIG When this is on, it means that the synergic mode is active and that the operator can set just the welding current while the other parameters are automatically regulated by the machine. The synergy is optimised by angle welding.
D1		Data setting: The display shows the acronym of the parameter to be set. Welding: The display shows the effective amperes value during welding. HOLD function: The display shows the average current value measured over the entire welding period (excluding the starting and ending ramps).
D2		Data setting: The display shows the value of the selected parameter. Welding: The display shows the effective voltage during welding operations. HOLD function: The display shows the average voltage value measured over the entire welding period (excluding the starting and ending ramps).
S1		Press the button to select the parameter to be set. Possible choices: Q-START - DYNAMIC ARC - MULTI TACK

CODE	SYMBOL	DESCRIPTION
S2		<p>Press and release: the button selects the first level menu parameters.</p> <p>Hold down for 3 seconds: the button opens the second level menu. When in the menu press and release the button to select the parameters.</p> <p>Keep the button pressed while powering on the power source: the button opens the SETUP menu.</p>
S3		<p>Press and release: the button opens the JOBs upload menu.</p> <p>Hold down for 3 seconds: the button opens the JOBs save and delete menu.</p>
S4		<p>Press and release: the button enables the device to receive the welding current control signal from a remote controller.</p> <p>Hold down for 3 seconds: the button activates a connected remote controller, if available, which is then used to manage all functions of the welding power source from a distance.</p>
S5		<p>TIG DC / TIG AC mode: This button selects the torch trigger procedure.</p> <p>① See § 4.1 page 19.</p> <p>MMA mode: Press the button to show the selected electrode type for MMA welding.</p>
S6		This button selects the welding mode.
E1		<p>Data setting: The encoder sets the value of the selected parameter.</p> <p>Welding: The encoder sets the value of the following parameter: WELDING CURRENT</p>

3.2 UNIT POWER-UP

Set the welding power source ON/OFF switch to "I" to switch on the unit.

- ➡ The message appears on the following displays: D2
x.x= software version

First power-up or power-ups following a RESET procedure

The welding power source sets up for welding with the factory presets.

Subsequent power-ups

The welding power source sets up for welding in the latest stable welding configuration that was active at the time of power-off.

3.3 RESET (LOAD FACTORY SETTINGS)

The reset procedure involves complete restoration of the default values, parameters and memory settings set in the factory.

The reset procedure is useful in the following cases:

- Too many changes made to the welding parameters so user finds it difficult to restore defaults.
- Unidentified software problems that prevent the welding power source from functioning correctly.

3.3.1 PARTIAL RESET

The reset procedure involves restoration of the parameter values and settings, except the following settings:

- Settings of the SETUP menu.
- saved JOBS.

Set the welding power source ON/OFF switch to "O" to switch the unit off.

- S1  S6  Hold down both buttons simultaneously.

Set the welding power source ON/OFF switch to "I" to switch on the unit.

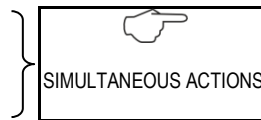

- ➡ The message appears on the following displays: D1-D2

Exit without confirmation

-  Press any button (except S3).
➡ This action will automatically close the menu.

Exit with confirmation

- S3  Press the button.
Wait for the memory clear procedure to terminate.
➡ This action will automatically close the menu.

3.3.2 TOTAL RESET

The reset procedure involves complete restoration of the default values, parameters and memory settings set in the factory.

All memory locations will be reset and hence all your personal welding settings will be lost!

Set the welding power source ON/OFF switch to "O" to switch the unit off.

- S1  S6  Hold down both buttons simultaneously.

Set the welding power source ON/OFF switch to "I" to switch on the unit.

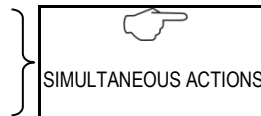

- ➡ The message appears on the following displays: D1-D2

- E1  Select the following setting with the encoder:

Exit without confirmation

-  Press any button (except S3).
➡ This action will automatically close the menu.

Exit with confirmation

- S3  Press the button.
Wait for the memory clear procedure to terminate.
➡ This action will automatically close the menu.

3.4 SET-UP (INITIAL SET-UP OF THE WELDING POWER SOURCE)

Set the welding power source ON/OFF switch to "O" to switch the unit off.

S2  Press the button.

Set the welding power source ON/OFF switch to "I" to switch on the unit.

 SIMULTANEOUS ACTIONS

 **SET UP** The message appears for a few seconds on the following displays: D1-D2

 **Coo Aut** The message appears on the following displays: D1-D2

S2  Use this button to scroll the settings to edit.

E1  Using the encoder, edit the value of the selected setting.

Exit without confirmation

 Press any button (except S2).

 This action will automatically close the menu.

Exit with confirmation

S2  Press the button.

 This action will automatically close the menu.

Tab. 1 - Setup settings

ACRONYM	SETTING	MIN	DEFAULT	MAX
Coo	COOLER ACTIVATION	Aut	Aut	oFF
St.C.	STARTING CURRENT	%	%	A
F.Cu.	FINAL CURRENT	%	%	A
HF.C.	HF CURRENT	20 A	SYn	250 A
HF.t.	HF TIME	0.5 s	2.0 s	3.0 s
PUL.	TYPE OF PULSED CURRENT	SLo.	FA.	FA.
P.A.	PILOT ARC	oFF	on	on
E.C.C.	CONTACT COMMAND EXPANSION	oFF	oFF	on

COOLER ACTIVATION

ON= The cooler is always running when the power source is switched on. This mode is preferable for heavy duty and automatic welding procedures.

OFF= The cooler is always disabled because an air-cooled torch is in use.

AUT= When the unit is switched on the cooler is switched on for 15 s. During welding procedures the cooler runs constantly. When welding is terminated the cooler continues to run for 90 s + a number of seconds equivalent to the average current value shown using the HOLD function.

Torch loading



WARNING!

Make sure the torch in use is correctly sized in relation to the welding current required and for the available and selected cooling type. This prevents the risk of burns to which the operator is potentially exposed, potential faults, and irreversible damage to the torch and the system. If a torch is installed or replaced while the unit is running, the circuit of the newly installed must be filled with coolant to avoid the risk of damage to the torch in the case of high voltage arc strikes without any liquid in the circuit.

Power-up with operation of the cooler set to "ON" or "AUT" mode

A check is performed automatically of the presence of liquid in the cooling circuit and the cooler is switched on for 15 seconds.

If the coolant circuit is full, the power source sets up in the most recent stable welding configuration.

If the coolant circuit is not full, all functions are inhibited and there will be no output power present.

 **AL. Coo.** The message appears on the following displays: D1-D2

(any)  Press the button or torch trigger to repeat the checking procedure for an additional 15 seconds. If the problem persists rectify the cause of the alarm.

Power-up with operation of the cooler set to "OFF"

Operation of the cooler and the cooler alarm are disabled.

Welding is performed without liquid cooling of the torch.

Torch change-over with operation of the cooler set to "ON"

Press and release the torch trigger.

 This serves to start the cooler for 15 seconds to fill the torch cooling circuit.

STARTING CURRENT

The value of this parameter can be set as a percentage of the welding current or as an absolute value expressed in Amperes.

FINAL CURRENT

The value of this parameter can be set as a percentage of the welding current or as an absolute value expressed in Amperes.

HF CURRENT

This parameter establishes the current value during HF discharge. The value of this parameter can be set as an absolute value or in SYN. With SYN setting the HF current value is calculated automatically on the basis of the preset welding current value.

Consequences of a higher value:

- Arc striking is facilitated, even on very dirty workpieces.
- Risk of piercing excessively thin gauge workpieces.

TYPE OF PULSED CURRENT

SLo.= This setting enables slow pulsed mode.

FA.= This setting enables fast pulsed mode.

HF TIME

This parameter defines maximum high frequency (HF) arc strike duration.

PILOT ARC

The function enables the output of a low current between the 1st and 2nd times of the torch trigger to shield the mask in advance and avoid the risk of blinding flashback caused by the welding current.

CONTACT COMMAND EXPANSION

The function enables the emission of the ARC-ON and ALARM signals via the signals connector for automatic application (See § CONNECTOR FOR "REMOTE2" page 43).

3.5 ALARMS MANAGEMENT

 This LED illuminates if an incorrect operating condition occurs.

 An alarm message appears on the following display: D2

Tab. 2 - Alarm messages

MESSAGE	MEANING	EVENT	CHECKS
AL. HEA.	Overheating alarm Indicates tripping of the welding power source thermal protection. Leave the unit running so that the overheated components cool as rapidly as possible. When the unit has cooled, the welding power source will reset automatically.	All functions disabled. Exceptions: - Cooling fan. - Cooler (if switched on).	<ul style="list-style-type: none"> - Make sure that the power required by the welding process is lower than the maximum rated power output. - Check that the operating conditions are in compliance with the welding power source data plate specifications. - Check for the presence of adequate air circulation around the welding power source.
	Phase missing alarm Indicates the absence of a phase in the power supply line. The message appears when the mains protection activation LED switches on.	All functions disabled. Exceptions: - Cooling fan.	<ul style="list-style-type: none"> - Check if the equipment power supply line has all the phases. If the problem persists: <ul style="list-style-type: none"> - qualified technical personnel are required for repair/maintenance jobs.
AL. Coo.	Cooler alarm Indicates insufficient pressure in the torch liquid cooling circuit.	All functions disabled. Exceptions: - Cooling fan. The alarm message persists on the display until the first operation is performed on the user interface. Signalling of the alarm depends on the following settings: - Coo = on: the alarm is signalled if the cooling unit is connected to the power source and if it is running. - Coo = oFF: the alarm is never signalled, irrespective of the circumstances. - Coo = Aut: the alarm is signalled if the cooling unit is connected to the power source and if it is running.	<ul style="list-style-type: none"> - Check that the connection to the cooler is correct. - Check that the "O/I" switch is set to "I" and that it illuminates when the pump is running. - Check that the cooler is filled with coolant. - Check that the cooling circuit is liquid tight, notably the torch hoses and the internal connections of the cooler.
E. 69	Software compatibility error Indicates that the welding power source has a software version that is not compatible with the remote device connected to it (remote controller, wire feed unit).	All functions disabled. Exceptions: - Cooling fan.	<ul style="list-style-type: none"> - Update the remote device software.
E. 04	Alarm, no-load voltage failure	All functions disabled. Exceptions: - Cooling fan.	<ul style="list-style-type: none"> - Check to ensure the welding torch is not resting on the workpiece connected to ground. - Check that when the power source is switched on there is no short circuit between the sockets (voltage must be greater than/equivalent to U_r). If the problem persists: <ul style="list-style-type: none"> - qualified technical personnel are required for repair/maintenance jobs.

MESSAGE	MEANING	EVENT	CHECKS
E. 05	<p>Torch button alarm Indicates that when the power source was powered up a short circuit was detected on the torch trigger input. When the unit has cooled, the welding power source will reset automatically.</p>	<p>All functions disabled. Exceptions: - Cooling fan.</p>	<p>- Make sure the torch trigger is not pressed, jammed, or short circuiting. - Make sure the torch and torch connector are intact.</p>
CAn Err.	<p>No communication alarm Indicates the presence of problems in data communication between the power source and wire feeder. When the unit has cooled, the welding power source will reset automatically. Exit the alarm state by performing one of the following actions: Switch the power source off.</p>	<p>All functions disabled. Exceptions: - cooling fan. - cooler (if switched on).</p>	<p>- Check that the connecting cable between power source and wire feeder is intact and make sure the connectors are securely tightened. If the problem persists: - qualified technical personnel are required for repair/maintenance jobs.</p>

4 WELDING SETTINGS

4.1 TORCH TRIGGER PROCEDURE

2 STROKE LIFT-ARC WELDING (2T)

1. Touch the workpiece with the torch electrode.
2. Press (1T) and keep the torch trigger pressed.
3. Slowly lift the torch to strike the arc.
- ➡ The welding current reaches the preset value, by way of a up slope time, if programmed.
4. Release (2T) the trigger to start the weld completion procedure.
- ➡ The current reaches the end current value in the time set in the down slope time parameter.
- ➡ The arc is extinguished.
- ➡ Gas delivery continues for the time set in the post gas parameter.

2 STROKE WELDING WITH HIGH FREQUENCY ARC STRIKE (2T HF)

1. Bring the torch up to the work until the electrode tip is approximately 2 or 3 mm away.
2. Press (1T) and keep the torch trigger pressed.
- ➡ The arc strikes without contact with the workpiece and the voltage discharges (HF) cease automatically.
- ➡ The welding current reaches the preset value, by way of a up slope time, if programmed.
3. Release (2T) the trigger to start the weld completion procedure.
- ➡ The current reaches the end current value in the time set in the down slope time parameter.
- ➡ The arc is extinguished.
- ➡ Gas delivery continues for the time set in the post gas parameter.

4 STROKE LIFT-ARC WELDING (4T)

1. Touch the workpiece with the torch electrode.
2. Press (1T) and release (2T) the torch trigger.
3. Slowly lift the torch to strike the arc.
- ➡ The welding current reaches the preset value, by way of a up slope time, if programmed.
4. Press (3T) the trigger and keep it pressed to start the weld completion procedure.
- ➡ The current reaches the end current value in the time set in the down slope time parameter.
- ➡ The arc continues and the current output will be the value set in the end current parameter.
- ⓘ In these conditions the weld pool can be closed (crater filler current).
5. Release (4T) the trigger to extinguish the arc.
- ➡ Gas delivery continues for the time set in the post gas parameter.

4 STROKE WELDING WITH HIGH FREQUENCY ARC STRIKE (4T HF)

1. Bring the torch up to the work until the electrode tip is approximately 2 or 3 mm away.
2. Press (1T) and release (2T) the torch trigger.
- ➡ The arc strikes without contact with the workpiece and the voltage discharges (HF) cease automatically.
- ➡ The welding current reaches the preset value, by way of a up slope time, if programmed.
3. Press (3T) the trigger and keep it pressed to start the weld completion procedure.
- ➡ The current reaches the end current value in the time set in the down slope time parameter.
- ➡ The arc continues and the current output will be the value set in the end current parameter.
- ⓘ In these conditions the weld pool can be closed (crater filler current).
4. Release (4T) the trigger to extinguish the arc.
- ➡ Gas delivery continues for the time set in the post gas parameter.

4 STROKE B-LEVEL WELDING (4T B-L)

1. Touch the workpiece with the torch electrode.
2. Press (1T) and release (2T) the torch trigger.
3. Slowly lift the torch to strike the arc.
- ➡ The welding current reaches the preset value, by way of a up slope time, if programmed.
3. Press and immediately release the torch trigger to switch to the second welding current.
- ⓘ The trigger must not be pressed for more than 0.3 seconds; otherwise, the weld completion stage will start.
- ⓘ When the trigger is pressed and released immediately, the system returns to the welding current.
4. Press (3T) the trigger and keep it pressed to start the weld completion procedure.
- ➡ The current reaches the end current value in the time set in the down slope time parameter.
- ➡ The arc continues and the current output will be the value set in the end current parameter.
- ⓘ In these conditions the weld pool can be closed (crater filler current).
5. Release (4T) the trigger to extinguish the arc.
- ➡ Gas delivery continues for the time set in the post gas parameter.

4 STROKE B-LEVEL WELDING WITH HIGH FREQUENCY ARC STRIKE (4T B-L HF)

1. Bring the torch up to the work until the electrode tip is approximately 2 or 3 mm away.
2. Press (1T) and release (2T) the torch trigger.
 - ➡ The arc strikes without contact with the workpiece and the voltage discharges (HF) cease automatically.
 - ➡ The welding current reaches the preset value, by way of a up slope time, if programmed.
3. Press and immediately release the torch trigger to switch to the second welding current.
 - ⓘ The trigger must not be pressed for more than 0.3 seconds; otherwise, the weld completion stage will start.
 - ⓘ When the trigger is pressed and released immediately, the system returns to the welding current.
4. Press (3T) the trigger and keep it pressed to start the weld completion procedure.
 - ➡ The current reaches the end current value in the time set in the down slope time parameter.
 - ➡ The arc continues and the current output will be the value set in the end current parameter.
 - ⓘ In these conditions the weld pool can be closed (crater filler current).
5. Release (4T) the trigger to extinguish the arc.
 - ➡ Gas delivery continues for the time set in the post gas parameter.

2 STROKE TACKING WELDING (2T Q-SPOT)

1. Touch the workpiece with the torch electrode.
2. Press (1T) and keep the torch trigger pressed.
3. Slowly lift the torch to strike the arc.
4. Release (2T) the torch trigger.
 - ➡ The welding current reaches the preset value, by way of a up slope time, if programmed.
 - ➡ The welding procedure continues, at the preset current, for the time set with the spot time parameter.
 - ➡ The current reaches the end current value in the time set in the down slope time parameter.
 - ➡ The arc is extinguished.
 - ➡ Gas delivery continues for the time set in the post gas parameter.

2 STROKE TACKING WELDING WITH HIGH FREQUENCY ARC STRIKE (2T Q-SPOT HF)

1. Bring the torch up to the work until the electrode tip is approximately 2 or 3 mm away.
2. Press (1T) the torch trigger.
 - ➡ The arc strikes without contact with the workpiece and the voltage discharges (HF) cease automatically.
3. Release (2T) the torch trigger.
 - ➡ The welding current reaches the preset value, by way of a up slope time, if programmed.
 - ➡ The welding procedure continues, at the preset current, for the time set with the spot time parameter.
 - ➡ The current reaches the end current value in the time set in the down slope time parameter.
 - ➡ The arc is extinguished.
 - ➡ Gas delivery continues for the time set in the post gas parameter.

Keep pressed torch trigger procedure

1. Bring the torch up to the work until the electrode tip is approximately 2 or 3 mm away.
2. Press (1T) the torch trigger.
 - ➡ The arc strikes without contact with the workpiece and the voltage discharges (HF) cease automatically.
 - ➡ The welding current reaches the preset value, by way of a up slope time, if programmed.
 - ➡ The welding procedure continues, at the preset current, for the time set with the spot time parameter.
 - ➡ The current reaches the end current value in the time set in the down slope time parameter.
 - ➡ The arc is extinguished.
 - ➡ Gas delivery continues for the time set in the post gas parameter.
3. Touch the workpiece with the torch electrode.
4. Slowly lift the torch to strike the arc.

PILOT ARC WELDING

The pilot arc can be activated in the following torch trigger procedures:

- 4T WELDING
- 4T HF WELDING
- 4T B-L HF WELDING

The welding procedure with pilot arc differs with respect to the procedure without pilot arc in the part of the torch trigger procedure described below.

LIFT-ARC Welding

1. Touch the workpiece with the torch electrode.
2. Press (1T) and keep the torch trigger pressed.
3. Slowly lift the torch to strike the arc.
- ➡ The arc strikes, the welding current assumes the pilot current value.
4. Release (2T) the torch trigger.
- ➡ The welding current reaches the preset value, by way of a up slope time, if programmed.
etc.

Welding with HF

1. Press (1T) and keep the torch trigger pressed.
- ➡ The arc strikes without contact with the part and the voltage discharges (HF) cease automatically, the welding current will assume the pilot current value.
2. Release (2T) the torch trigger.
- ➡ The welding current reaches the preset value, by way of a up slope time, if programmed.
etc.

4.2 SELECTION OF THE WELDING MODE AND TORCH TRIGGER PROCEDURE

Specific torch trigger procedures are available in accordance with the selecting welding mode.

The availability of certain procedures depends on whether or not certain parameters or functions of the unit are enabled or set in the associated menus.









The table shows the settings to be made to enable each procedure.

KEY

- 2T: 2 STROKE LIFT-ARC
- 2T HF: 2 STROKE WITH HIGH FREQUENCY ARC STRIKE (HF)
- 4T: 4 STROKE LIFT-ARC
- 4T HF: 4 STROKE WITH HIGH FREQUENCY ARC STRIKE (HF)
- 4T B-L: 4 STROKE B-LEVEL
- 4T B-L HF: 4 STROKE B-LEVEL WITH HIGH FREQUENCY ARC STRIKE (HF)
- 2T Q-SPOT: 2 STROKE TACKING
- 2T Q-SPOT HF: 2 STROKE TACKING WITH HIGH FREQUENCY ARC STRIKE (HF)
- ✓: Always available.
- 1: Available with the following setting: HF= on

S6  Use this button to select one of the following welding modes.

S5  Use this button to select one of the following torch trigger procedures.

MODE	PROCEDURE							
								
MMA								
DESEAMING MODE								
TIG DC CONTINUOUS	✓	1	✓	1	✓	1	✓	1
PULSED DC TIG	✓	1	✓	1	✓	1	✓	1
SYNERGIC PULSED DC TIG	✓	1	✓	1	✓	1	✓	1
AC TIG	✓	1	✓	1	✓	1	✓	1
PULSED AC TIG	✓	1	✓	1	✓	1	✓	1

4.3 WELDING PARAMETERS

For a better understanding of the parameter functions described in the table, refer to the following diagram.

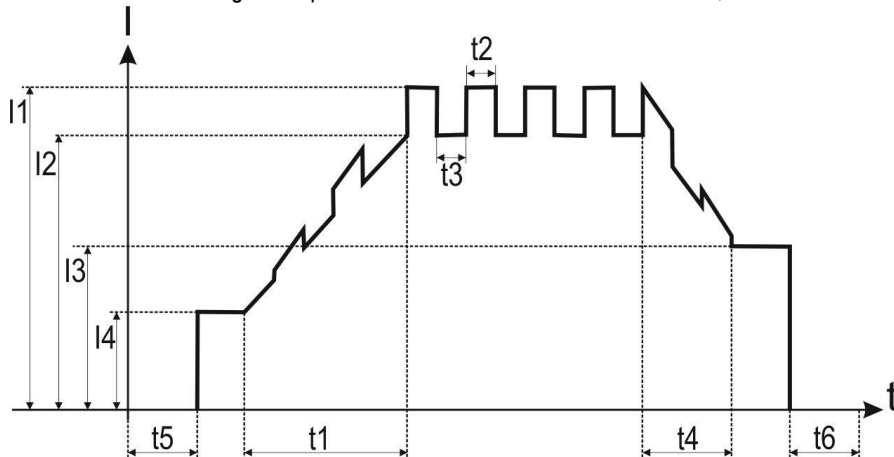

- (I1) WELDING CURRENT
- (I2) BASE CURRENT
- (I3) FINAL CURRENT
- (I4) STARTING CURRENT
- (t1) UP SLOPE TIME
- (t2) PEAK TIME
- (t3) BASE TIME
- (1/t2+t3) PULSED CURRENT FREQUENCY
- (t4) DOWN SLOPE TIME
- (t5) PRE GAS TIME
- (t6) POST GAS TIME

WELDING CURRENT

Output current value during welding.

- This parameter allows a shielded environment to be created, thereby eliminating contaminants at the start of the welding pass.

MAXIMUM CURRENT WITH REMOTE CONTROLLER

Maximum output current value that can be achieved with remote controller external reference.

STARTING CURRENT

Unit current output value immediately after the arc strike. The usefulness of having an adjustable initial welding current is that of avoiding welding the part with excessively high current values and thus potentially damaging it.

HOT-START

This parameter aids electrode melting at the time of arc striking.

Consequences of a higher value:

- Easier arc strike.
- Increased spatter at welding start.
- Increase of strike area.

Consequences of a lower value:

- More difficult arc strike.
- Less spatter at welding start.
- Smaller strike area.

SLOPE UP

Time during which the current changes from the starting value to the welding value by means of a slope.

This setting is used to avoid damaging the edges of the joint with excessively high current values at the moment of arc striking. The value of the main welding current is increased gradually in order to control the uniformity of material deposition and weld penetration.

ARC FORCE

This parameter helps to avoid electrode sticking during welding. During electrode fusion low conductivity parts of the coating become detached and tend to become interposed between the electrode tip as it is fusing and the workpiece. This condition results in an interruption of the arc. In addition, it may occur that the electrode comes into contact with the workpiece creating a short circuit and consequent quenching of the arc. To avoid arc quenching the power source therefore delivers instantaneous peak currents in correspondence with preset arc voltage thresholds.

Consequences of a higher value:

- Fluidity during welding.
- Welding arc stability.
- Greater electrode fusion in workpiece.
- More welding spatter.

Consequences of a lower value:

- The arc is extinguished more easily.
- Less welding spatter.

SECOND CURRENT B-LEVEL

With a rapid press and release (less than 0.5 seconds) of the torch trigger during welding, the output current value switches to the value set by means of the "B-level second current" parameter.

This function makes it possible to avoid interrupting the welding process when the geometry of the workpiece changes; alternatively, the welding current can be reduced to decrease heating of the part if it becomes too hot during execution of the welding process.

In DC TIG welding, the parameter is useful when welding different gauge workpieces during the same pass; when moving between different gauges the output current can be changed simply by pressing the torch trigger.

BASE CURRENT

Pulsed wave minimum current.

Consequences of a higher value:

- Faster creation of weld pool.
- Increase of heat-affected zone.

PRE-GAS TIME

Time of gas delivery before the arc strike.

This adjustment is required when fixing points must be created or when welding in hard-to-reach positions that call for the presence of inert atmospheres before striking the arc.

Consequences of a higher value:

PEAK TIME

Time for which the current pulse is at the maximum value.

Consequences of a higher value:

- Greater weld penetration.
 - Facility to make deeper cuts.
- Consequences of a lower value:
- Reduction of heat-affected zone.
 - Difficult to create a weld pool.

PULSED CURRENT FREQUENCY

Consequences of a higher value:

- Slower melt speed.
- Reduction of heat-affected zone.

BASE TIME

Time during which current output is at the base value.

Consequences of a higher value:

- The filler material is spread more evenly.
- Increase of heat-affected zone.

DOWN SLOPE

Time during which the current changes from the welding value to the end value by means of a slope.

FINAL CURRENT

During electrode welding the parameter makes it possible to obtain a uniform deposit of filler material from the start to the end of the welding process, closing the deposition crater with a current such as to deposit a final droplet of filler material.

By keeping the torch trigger pressed during the 3rd time, the crater filler current is maintained thereby ensuring optimal crater filling, until the post gas time is started by releasing the torch trigger (4th time).

POST GAS TIME

Time of post gas delivery when the welding arc is extinguished.

Consequences of a higher value:

- More effective pickling (improved appearance of workpiece at the end of the welding pass).
- Higher gas consumption.

Consequences of a lower value:

- Lower gas consumption.
- Oxidation of electrode tip (more difficult arc strike).

ELECTRODE TYPE

The type of welding electrode can be selected.

Each electrode is associated with specific threshold values for Arc-Force and long arc Voltage.

VRD

This parameter reduces the potential across the welding sockets when welding is not in progress.

The arc strike procedure is as follows:

- Touch the workpiece with the electrode tip.
- Raise the electrode.
- Power is released for several seconds.
- Touch the workpiece with the electrode tip.
- The welding arc will strike.

LONG ARC VOLTAGE

This parameter inhibits power output when the potential between electrode and workpiece exceeds the preset threshold level.

Consequences of a higher value:

- The welding arc persists even with a significant distance between the electrode and the workpiece.
- Consequences of a lower value:
- Faster exit from weld.

SPOT TIG TIME

When the torch trigger is pressed the welding arc persists for the time set in the parameter.

Press the torch trigger again to resume the welding process.

The result of this is a very precise, not oxidized welding spot without any plastic deformation of the sheet.

HF ARC START

This parameter enables the arc strike in the TIG welding procedure by means of a high frequency (HF) current discharge.

The high frequency arc strike (HF) prevents the inclusion of impurities at the start of the weld pass.

WARNING: The high frequency arc strike (HF) can harm electronic boards when welding is performed on equipment that incorporates such devices.

MINIMUM PEDAL CURRENT

Minimum output current value with foot pedal controller external reference.

The current is set as a percentage with respect to the "maximum foot pedal current" parameter.

AC WAVEFORM

This parameter allows selection of the required AC waveform.

AC WAVEFORM	CHARACTERISTICS
Sine	Low noise
Square	High noise Greater penetration Reduced pickling
Sawtooth	Medium noise

Q-START

This parameter allows the unit to start in synergic pulsed TIG mode for the preset time interval, before switching automatically to the welding procedure selected on the interface panel.

The parameter creates a weld pool faster with respect to the standard starting procedure.

This parameter is useful when spot welding thin gauge sheet.

DYNAMIC ARC

Welding power remains constant even when the distance between electrode and workpiece changes.

Consequences of a higher value:

- The welding arc concentration remains unchanged.
- Prevents electrode sticking.
- Thin workpieces may become deformed more easily.

MULTI TACK

This parameter allows thin gauge sheet to be welded without deformation.

Consequences of a higher value:

- Welding of thinner gauge sheet without deformation.
- Less melting of material, slower welding process.

MIX AC

This parameter serves to set the AC wave percentage with respect to the DC current output.

Consequences of a higher value:

- Greater weld penetration.
- Less deformation.
- Faster creation of the weld pool.
- Reduced cleanliness of the workpiece.
- Loss of arc.

FUSIONE EXTRA

This parameter establishes the percentage of the positive current wave (pickling) that is subtracted and added to the negative current (fusion).

The following picture shows the positive wave interval ΔI that, if subtracted and added to the negative wave, forms the new form of broken line wave.

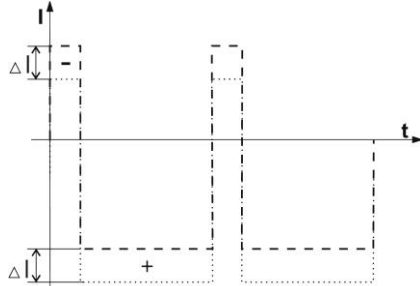

Consequences of a higher value:

- Tighter arc.
- Greater weld penetration.
- Reduced pickling.
- Loss of arc.
- Less deformation of the electrode.

AC FREQUENCY

The picture below shows the example where the wave on the second graph has a double frequency compared with the first.

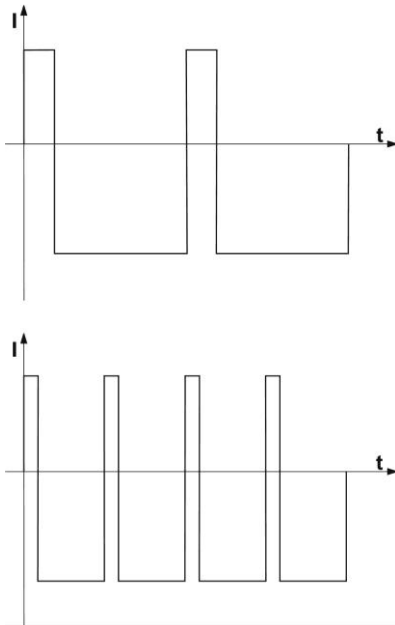

Consequences of a higher value:

- Arc concentration.
- Reduction of heat-affected zone.
- Slower melt speed.

AC BALANCE

This parameter establishes the positive wave vs. negative wave time ratio.

The following figure shows two graphs with different balance value: the first graph represents the curve of the current with a negative value balance (more penetration) in which it can be seen that there is a low percentage of positive wave compared with the negative.

In the second graph the current curve is shown with a positive value balance (more cleaning); in this case the percentage of the positive wave is greater than the negative one.

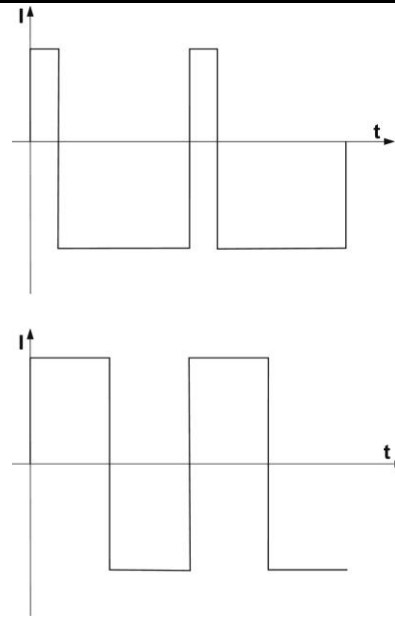

Consequences of a higher value:

- Greater weld penetration.
- Less cleanliness.

ELECTRODE DIAMETER

The parameter optimizes the AC TIG welding arc strike on the basis of the diameter of the chosen electrode.

4.4 PARAMETERS ACTIVATION

The welding parameters are available in accordance with the selected welding mode and procedure.
Certain parameters are available only after other parameters or functions of the unit have been enabled or set.
The table shows the settings required to enable each parameter.

KEY

✓: Always available.

- 1: Available with the following setting: MULTI TACK = OFF
- 2: Available when remote control is enabled and a remote control pedal is connected to the unit.
- 3: Available with the following setting: HF ARC START = ON
- 4: Available when foot pedal controller is disabled.
- 5: Available with the following setting: TYPE OF PULSED CURRENT = SLO.
- 6: Available with the following setting: TYPE OF PULSED CURRENT = FA.





Meaning of symbols

1+2= All conditions must be fulfilled (both 1 and 2).

MENU	MODE →	F		Q-SPOT				Q-SPOT				SYN			
		✓	✓	↕	↕	↕	↕	↕	↕	↕	↕	↕	↕	↕	↕
↓	PROCEDURE →			↕	↕	↕	↕	↕	↕	↕	↕	↕	↕	↕	↕
	PARAMETER ↓														
1°	WELDING CURRENT	✓	✓	✓	✓	✓	✓	✓	✓	✓	✓	✓	✓	✓	✓
1°	HOT-START	✓													
1°	ARC FORCE	✓													
1°	PRE-GAS TIME			3	3	3	3	3	3	3	3	3	3	3	3
1°	STARTING CURRENT			✓	✓	✓	✓	✓	✓	✓	✓	✓	✓	✓	✓
1°	SLOPE UP			✓	✓	✓	✓	✓	✓	✓	✓	✓	✓	✓	✓
1°	SECOND CURRENT B-LEVEL					✓				✓			✓		
1°	BASE CURRENT							✓	✓	✓	✓	✓	✓	✓	✓
1°	PEAK TIME							✓	✓	✓	✓	✓	✓	✓	✓
1°	PULSED CURRENT FREQUENCY							6	6	6	6	6	6	6	6
1°	BASE TIME							5	5	5	5				
1°	DOWN SLOPE			✓	✓	✓	✓	✓	✓	✓	✓	✓	✓	✓	✓
1°	FINAL CURRENT			✓	✓	✓	✓	✓	✓	✓	✓	✓	✓	✓	✓
1°	POST GAS TIME			✓	✓	✓	✓	✓	✓	✓	✓	✓	✓	✓	✓
2°	ELECTRODE TYPE	✓													
2°	VRD	✓	✓												
2°	LONG ARC VOLTAGE	✓													
2°	SPOT TIG TIME						✓				✓				✓
2°	HF ARC START			✓	✓	✓	✓	✓	✓	✓	✓	✓	✓	✓	✓
2°	MINIMUM PEDAL CURRENT			2			2	2			2	2			2
2°	AC WAVEFORM														
SPECIAL	Q-START			3+1	3+1	3+1		3+1	3+1	3+1					
SPECIAL	DYNAMIC ARC			4+1	1			4+1	1						
SPECIAL	MULTI TACK			3	3			3	3			3	3		
SPECIAL	MIX AC														
SPECIAL	FUSIONE EXTRA														
SPECIAL	AC FREQUENCY														
SPECIAL	AC BALANCE														
SPECIAL	ELECTRODE DIAMETER														

MENU	MODE →	AC				AC			
									
↓	PROCEDURE →								
	PARAMETER ↓								
1°	WELDING CURRENT	1	1	1	1	1	1	1	1
1°	HOT-START								
1°	ARC FORCE								
1°	PRE-GAS TIME	3	3	3	3	3	3	3	3
1°	STARTING CURRENT	✓	✓	✓	✓	✓	✓	✓	✓
1°	SLOPE UP	✓	✓	✓	✓	✓	✓	✓	✓
1°	SECOND CURRENT B-LEVEL				✓				✓
1°	BASE CURRENT					✓	✓	✓	✓
1°	PEAK TIME					✓	✓	✓	✓
1°	PULSED CURRENT FREQUENCY					6	6	6	6
1°	BASE TIME					5	5	5	5
1°	DOWN SLOPE	✓	✓	✓	✓	✓	✓	✓	✓
1°	FINAL CURRENT	✓	✓	✓	✓	✓	✓	✓	✓
1°	POST GAS TIME	✓	✓	✓	✓	✓	✓	✓	✓
2°	VRD								
2°	LONG ARC VOLTAGE								
2°	SPOT TIG TIME		✓				✓		
2°	HF ARC START	✓	✓	✓	✓	✓	✓	✓	✓
2°	MINIMUM PEDAL CURRENT	2	2			2	2		
2°	AC WAVEFORM	✓	✓	✓	✓	✓	✓	✓	✓
SPECIAL	Q-START								
SPECIAL	DYNAMIC ARC								
SPECIAL	MULTI TACK								
SPECIAL	MIX AC	✓	✓	✓	✓	✓	✓	✓	✓
SPECIAL	FUSIONE EXTRA	✓	✓	✓	✓	✓	✓	✓	✓
SPECIAL	AC FREQUENCY	✓	✓	✓	✓	✓	✓	✓	✓
SPECIAL	AC BALANCE	✓	✓	✓	✓	✓	✓	✓	✓
SPECIAL	ELECTRODE DIAMETER	✓	✓	✓	✓	✓	✓	✓	✓

4.5 PARAMETERS SETTING: (1ST LEVEL)

- S2  Press this button to scroll the list of settings to edit.
-  The acronym relative to the setting to be edited appears on the following displays: D1
-  The value relative to the selected setting appears on the following displays: D2
- E1  Using the encoder, edit the value of the selected setting.
The value is saved automatically.
-  Press any key (except S2) to save the setting and quit the menu.

Tab. 3 - Parameters of the 1st level menu: MMA mode

ACRONYM	PARAMETER	MIN	DEFAULT	MAX	
-	WELDING CURRENT MAXIMUM CURRENT WITH REMOTE CONTROLLER	10 A	10 A	500 A	*5
Ho.S.	HOT-START	0 %	*SYn	100 %	*1 *2
Ar.F.	ARC FORCE	0 %	*SYn	250 %	*1 *3

Tab. 4 - Parameters of the 1st level menu: DESEAMING mode

ACRONYM	PARAMETER	MIN	DEFAULT	MAX	
-	WELDING CURRENT MAXIMUM CURRENT WITH REMOTE CONTROLLER	10 A	10 A	500 A	*5

Tab. 5 - Parameters of the 1st level menu: CONTINUOUS DC TIG mode

ACRONYM	PARAMETER	MIN	DEFAULT	MAX	
Pr.G.	PRE-GAS TIME	0.0 s	0.1 s	10.0 s	
St.C.	STARTING CURRENT	5 A	50 A	500 A	*4 *8
Sl.u.	SLOPE UP	2 %	50 %	200 %	*4 *8
-	WELDING CURRENT MAXIMUM CURRENT WITH REMOTE CONTROLLER	0.0 s	0.0 s	25.0 s	
S.Cu.	SECOND CURRENT B-LEVEL	5 A	80 A	500 A	*5
Sl.d.	DOWN SLOPE	10 %	50 %	200 %	*1
F.Cu.	FINAL CURRENT	0.0 s	0.0 s	25.0 s	*8
Po.G.	POST GAS TIME	5 A	5 A	500 A	*4 *8
		5 %	5 %	80 %	*4 *8

Tab. 6 - Parameters of the 1st level menu: PULSED TIG DC mode

ACRONYM	PARAMETER	MIN	DEFAULT	MAX	
Pr.G.	PRE-GAS TIME	0.0 s	0.1 s	10.0 s	
St.C.	STARTING CURRENT	5 A	50 A	500 A	*4 *8
Sl.u.	SLOPE UP	2 %	50 %	200 %	*4 *8
-	WELDING CURRENT MAXIMUM CURRENT WITH REMOTE CONTROLLER	0.0 s	0.0 s	25.0 s	
S.Cu.	SECOND CURRENT B-LEVEL	5 A	80 A	500 A	*5
b.Cu.	BASE CURRENT	10 %	50 %	200 %	*1
PE.t.	PEAK TIME	1 %	40 %	200 %	
P.Fr.	PULSED CURRENT FREQUENCY	1 %	50 %	99 %	
bA.t.	BASE TIME	0.1 Hz	100 Hz	2.5 kHz	
Sl.d.	DOWN SLOPE	0.1 s	5.0 s	5.0 s	
F.Cu.	FINAL CURRENT	0.0 s	0.0 s	25.0 s	*8
Po.G.	POST GAS TIME	5 A	5 A	500 A	*4 *8
		5 %	5 %	80 %	*4 *8

*1: This parameter is set as a percentage referred to the value of the following parameter: WELDING CURRENT

*2: The value is limited to 250 A max.

*3: The value is limited to 500 A max.

*4: The value of this parameter can be set as a percentage of the welding current or as an absolute value expressed in Amperes.

*5: This setting is used to adjust both parameters.

*SYN: This code indicates that parameters control is synergic.

The optimal value of this parameter is set automatically by the microprocessor on the basis of the preset welding current value.

When SYN is installed, to display the synergic value press the following button: S5

This value can be displayed but it is not user-adjustable.

*8: The parameter is displayed but it is not used the during welding process when the following setting is present: MULTI TACK = ON

Tab. 7 - Parameters of the 1st level menu: SYNERGIC DC TIG mode

ACRONYM	PARAMETER	MIN	DEFAULT	MAX
Pr.G.	PRE-GAS TIME	0.0 s	*7	10.0 s
St.C.	STARTING CURRENT	5 A	*7	500 A *4
		2 %	*7	200 % *4
Sl.u.	SLOPE UP	0.0 s	*7	25.0 s
-	WELDING CURRENT			
	MAXIMUM CURRENT WITH REMOTE CONTROLLER	5 A	*7	500 A *5
S.Cu.	SECOND CURRENT B-LEVEL	10 %	*7	200 % *1
b.Cu.	BASE CURRENT	1 %	*6 *7	200 %
PE.t.	PEAK TIME	1 %	*6 *7	99 %
P.Fr.	PULSED CURRENT FREQUENCY	0.1 Hz	*6 *7	2.5 kHz
Sl.d.	DOWN SLOPE	0.0 s	*7	25.0 s
F.Cu.	FINAL CURRENT	5 A	*7	500 A *4
		5 %	*7	80 % *4
Po.G.	POST GAS TIME	0.0 s	*7	25.0 s

Tab. 8 - 1st level menu parameters in AC TIG mode

ACRONYM	PARAMETER	MIN	DEFAULT	MAX
Pr.G.	PRE-GAS TIME	0.0 s	0.1 s	10.0 s
St.C.	STARTING CURRENT	5 A	50 A	500 A
		2 %	50 %	200 %
Sl.u.	SLOPE UP	0.0 s	0.0 s	25.0 s
-	WELDING CURRENT			
	MAXIMUM CURRENT WITH REMOTE CONTROLLER	5 A	80 A	500 A *5
S.Cu.	SECOND CURRENT B-LEVEL	10 %	50 %	200 % *1
Sl.d.	DOWN SLOPE	0.0 s	0.0 s	25.0 s
		5 A	5 A	500 A
F.Cu.	FINAL CURRENT	5 %	5 %	80 %
Po.G.	POST-GAS TIME	0.0 s	10.0 s	25.0 s

Tab. 9 - 1st level menu parameters in PULSED AC TIG mode

ACRONYM	PARAMETER	MIN	DEFAULT	MAX
Pr.G.	PRE-GAS TIME	0.0 s	0.1 s	10.0 s
St.C.	STARTING CURRENT	5 A	50 A	500 A
		2 %	50 %	200 %
Sl.u.	SLOPE UP	0.0 s	0.0 s	25.0 s
-	WELDING CURRENT			
	MAXIMUM CURRENT WITH REMOTE CONTROLLER	5 A	80 A	500 A *5
S.Cu.	SECOND CURRENT B-LEVEL	10 %	50 %	200 % *1
b.Cu.	BASE CURRENT	1 %	40 %	200 %
PE.t.	PEAK TIME	0.1 s	5.0 s	5.0 s
		1 %	50 %	99 %
P.Fr.	PULSED CURRENT FREQUENCY	0.1 Hz	100 Hz	2.5 kHz
bA.t.	BASE TIME	0.1 s	5.0 s	5.0 s
Sl.d.	DOWN SLOPE	0.0 s	0.0 s	25.0 s
		5 A	5 A	500 A
F.Cu.	FINAL CURRENT	5 %	5 %	80 %
Po.G.	POST-GAS TIME	0.0 s	10.0 s	25.0 s

*1: This parameter is set as a percentage referred to the value of the following parameter: WELDING CURRENT

*4: The value of this parameter can be set as a percentage of the welding current or as an absolute value expressed in Amperes.







*5: This setting is used to adjust both parameters.

*6: This value can be displayed but it is not user-adjustable.

*7: The optimal value of this parameter is set automatically by the microprocessor on the basis of the preset welding current value.

*8: The parameter is displayed but it is not used during the welding process when the following setting is present: MULTI TACK = ON

4.6 PARAMETERS SETTING: (2ND LEVEL)

- S2  Hold down the button for 3 seconds to gain access to the 2nd level menu.
-  The acronym relative to the setting to be edited appears on the following displays: D1
-  The value relative to the selected setting appears on the following displays: D2
- S2  Press this button to scroll the list of settings to edit.
- E1  Using the encoder, edit the value of the selected setting.
The value is saved automatically.
-  Press any key (except S3) to save the setting and quit the menu.

Tab. 10 - Parameters of the 2nd level menu: MMA mode

ACRONYM	PARAMETER	MIN	DEFAULT	MAX
EL.	ELECTRODE TYPE	bAS	bAS	ALU
Urd	OUTPUT VOLTAGE REDUCTION	oFF	oFF	on
U.EL.	LONG ARC VOLTAGE	37	*SYn	70

bAS= basic
 rUt= rutile
 CEL=cellulosic
 Crn= chromium/nickel
 ALU= aluminium
 AC= alternating current

Tab. 11 - Parameters of the 2nd level menu: DESEAMING mode









ACRONYM	PARAMETER	MIN	DEFAULT	MAX
Urd	OUTPUT VOLTAGE REDUCTION	oFF	oFF	on

Tab. 12 - Parameters of the 2nd level menu: CONTINUOUS DC TIG mode, PULSED DC TIG mode, SYNERGIC DC TIG mode





ACRONYM	PARAMETER	MIN	DEFAULT	MAX
SP.t.	SPOT TIG TIME	0.01 s	0.01 s	10.0 s
HF	HF ARC STRIKE ENABLE	oFF	on	on
r.P.C.	MINIMUM PEDAL CURRENT	1 %	5 %	90 %

Tab. 13 - 2nd level menu parameters in AC TIG mode

ACRONYM	PARAMETER	MIN	DEFAULT	MAX
AC	AC WAVEFORM	1	1	9
SP.t.	SPOT TIG TIME	0.01 s	0.1 s	10.0 s
HF	HF ARC STRIKE ENABLE	on	on	oFF
r.P.C.	MINIMUM PEDAL CURRENT	1 %	5 %	90 %

VALUE	DC+	WAVEFORM	DC-
1	sine		sine
2	rectangular		rectangular
3	triangular		triangular
4	sine		rectangular
5	rectangular		sine
6	sine		triangular
7	triangular		sine
8	rectangular		triangular
9	triangular		rectangular

4.7 PARAMETERS SETTING: SPECIAL FUNCTIONS

- S1  Press this button to scroll the list of settings to edit.
-  The acronym relative to the setting to be edited appears on the following displays: D1
-  The value relative to the selected setting appears on the following displays: D2
- E1  Using the encoder, edit the value of the selected setting.
The value is saved automatically.
-  Press any key (except S1) to save the setting and quit the menu.

Tab. 14 - Special functions in MMA mode

ACRONYM	PARAMETER	MIN	DEFAULT	MAX
d.Ar.	DYNAMIC ARC	oFF	oFF	on

Tab. 15 - SPECIAL FUNCTIONS menu parameters: CONTINUOUS DC TIG mode, PULSED DC TIG mode

ACRONYM	PARAMETER	MIN	DEFAULT	MAX
q.St.	Q-START	0.1 s	oFF	10.0 s
d.Ar.	DYNAMIC ARC	1	oFF	50
M.tA.	MULTI TACK	0.5 Hz	oFF	6.0 Hz *1

Tab. 16 - SPECIAL FUNCTIONS menu parameters: SYNERGIC DC TIG mode

ACRONYM	PARAMETER	MIN	DEFAULT	MAX
M.tA.	MULTI TACK	0.5 Hz	oFF	6.0 Hz *1

Tab. 17 - Special functions in AC TIG and PULSED AC TIG modes

ACRONYM	PARAMETER	MIN	DEFAULT	MAX
M.AC.	MIX AC	10 %	oFF	80 %
E.Fu.	FUSIONE EXTRA	0.1 %	oFF	80 %
F.AC.	AC INVERSION FREQUENCY	20 Hz	65 Hz	200 Hz
bAL	AC BALANCE	-10	0	+10
d.EL.	AC TIG ELECTRODE DIAMETER	0,0 mm	2,4 mm	6,4 mm

*1: When this function is active welding is performed without the following parameters: SLOPE UP - SLOPE DOWN - START CURRENT - FINAL CURRENT

*2: The activation is suitable for the following welding modes: MMA - ELECTRODE GOUGING

*SYN: This code indicates that parameters control is synergic.

The optimal value of this parameter is set automatically by the microprocessor on the basis of the preset welding current value.

When SYN is installed, to display the synergic value press the following button: S5

This value can be displayed but it is not user-adjustable.

4.8 JOBS MANAGEMENT

Personalised welding settings, or JOBS, can be saved in memory locations and subsequently uploaded. Up to 50 JOBS can be saved (j01-j50). JOBS can be managed only when the unit is not in welding mode.

The SETUP menu settings cannot be saved by means of the JOBS.

When a JOB is loaded and an UP/DOWN torch is installed, press the torch triggers to select the saved JOBS.

If there are no JOBS loaded, the UP/DOWN buttons on the torch serve to adjust the welding current.

4.8.1 SAVING A JOB

S3  Hold down the button for 3 seconds.

 **SA. Job** The message appears on the following displays: D1-D2

S3  Press the button to confirm.

 **SA. J.xx** The message appears on the following displays: D1-D2

xx= number of the first free job.

E1  Use the encoder to select the required job number.

On selecting a currently occupied memory location, the job number flashes.

If you confirm at this point, the new job will overwrite the previously saved settings.

Exit without confirmation

 Press any button (except S3).

 This action will automatically close the menu.

Exit with confirmation

S3  Press the button.

 This action will automatically close the menu.

4.8.2 LOADING A USER JOB OF FACTORY SET JOB

S3  Press and release the button.

 **Lo. J.xx** Only when the jobs have been uploaded, the message is shown on the following displays: D1-D2

xx= number of the latest job used.

 **no Job** If there are no jobs in the memory the message is shown on the following displays: D1-D2

E1  Use the encoder to select the number of the job to be uploaded.

Exit without confirmation

 Press any button (except S3).

 This action will automatically close the menu.

Exit with confirmation

S3  Press the button.

 **J.xx** The message appears for a few seconds on the following displays: D1

 **JOB** The LED illuminates.

 This action will automatically close the menu.

To quit the currently loaded JOB, change any setting on the power source user interface.

4.8.3 DELETING A JOB

S3  Hold down the button for 3 seconds.

 **SA. Job** The message appears on the following displays: D1-D2

E1  Select the following setting with the encoder: **Er. Job**

The message appears only if there are saved JOBS, on the following displays: D1-D2

S3  Press the button to confirm.

 **Er. J.xx** The message appears on the following displays: D1-D2

xx= number of the latest job used.

E1  Use the encoder to select the number of the job to be deleted.

Exit without confirmation

 Press any button (except S3).

 This action will automatically close the menu.

Exit with confirmation

S3  Press the button.

 This action will automatically close the menu.

4.8.4 SELECTING A JOB WITH THE TORCH BUTTON







When an UP/DOWN torch is installed you can select the JOBS in a JOB sequence using the buttons on the welding torch. To create the JOBS sequence, leave a free memory slot before and after the group of JOBS to be included in the sequence.

J.01	} Sequence 1
J.02	
J.03	
JOB not saved	
J.05	} Sequence 2
J.06	
J.07	
JOB not saved	
J.09	} Sequence 3
J.10	
J.11	

Select and upload one of the JOBS in the required sequence (e.g. J.06) on the power source user interface. Use the torch buttons to scroll the JOBS of sequence 2 (J.05, J.06, J.07).

5 TECHNICAL DATA

5.1 GLW 502

Directives applied	Waste electrical and electronic equipment (WEEE)			
	Electromagnetic compatibility (EMC)			
	Low voltage (LVD)			
	Restriction of the use of certain hazardous substances (RoHS)			
Construction standards	EN 60974-1; EN 60974-3; EN 60974-10 Class A			
Conformity markings		Equipment compliant with European directives in force		
		Equipment suitable in an environment with increased hazard of electric shock		
		Equipment compliant with WEEE directive		
		Equipment compliant with RoHS directive		
Supply voltage	3 x 400 Va.c. ± 15 % / 50-60 Hz			
Mains protection	32 A 500 V Delayed			
Z_{max}	If this equipment is connected to a public low voltage system, it is the responsibility of the installer or user of the equipment to ensure, by consultation with the distribution network operator if necessary, that the equipment may be connected.			
Dimensions (L x D x H)	690 x 290 x 450 mm			
Weight	54.8 kg			
Insulation class	H			
Protection rating	IP23S			
Cooling	AF: Air-over cooling (fan assisted)			
Maximum gas pressure	0,5 MPa (5 bar)			
Static characteristic	MMA	 Drooping characteristic		
	TIG	 Drooping characteristic		
	MIG/MAG	 Flat characteristic		
Current and voltage adjustment range	MMA	5 A / 20.2 V - 500 A / 40.0 V		
	TIG	5 A / 10.2 V - 500 A / 30.0 V		
	MIG/MAG	20 A / 15.0 V - 500 A / 39.0 V		
Welding current / Working voltage	MMA	50 % (40° C)	500 A - 40.0 V	
		60 % (40° C)	450 A - 38.0 V	
		100 % (40° C)	400 A - 36.0 V	
	TIG	50 % (40° C)	500 A - 30.0 V	
		60 % (40° C)	460 A - 28.4 V	
		100 % (40° C)	400 A - 26.0 V	
	MIG/MAG	50 % (40° C)	500 A - 39.0 V	
		60 % (40° C)	450 A - 36.5 V	
		100 % (40° C)	400 A - 34.0 V	
	Maximum input power	MMA	50 % (40° C)	24.3 kVA – 22.2 kW
			60 % (40° C)	21.2 kVA – 19.0 kW
			100 % (40° C)	18.1 kVA – 15.9 kW
TIG		50 % (40° C)	18.2 kVA – 16.6 kW	
		60 % (40° C)	16.1 kVA – 14.4 kW	
		100 % (40° C)	13.0 kVA – 11.4 kW	
MIG/MAG		50 % (40° C)	23.7 kVA – 21.7 kW	
		60 % (40° C)	20.3 kVA – 18.3 kW	
		100 % (40° C)	17.5 kVA – 15.3 kW	
Maximum supply current	MMA	50 % (40° C)	35.1 A	
		60 % (40° C)	30.0 A	
		100 % (40° C)	25.5 A	
	TIG	50 % (40° C)	26.3 A	
		60 % (40° C)	22.8 A	
		100 % (40° C)	18.4 A	
	MIG/MAG	50 % (40° C)	34.3 A	
		60 % (40° C)	28.5 A	
		100 % (40° C)	24.3 A	

Maximum Effective Supply Current	MMA	50 % (40° C)	24.8 A
		60 % (40° C)	23.3 A
		100 % (40° C)	25.5 A
	TIG	50 % (40° C)	18.6 A
		60 % (40° C)	17.7 A
		100 % (40° C)	18.4 A
	MIG/MAG	50 % (40° C)	24.2 A
		60 % (40° C)	22.1 A
		100 % (40° C)	24.3 A
No-load voltage (U₀)	MMA	95 V	
	TIG	85 V	
	MIG/MAG	85 V	
Reduced no-load voltage (U_r)	MMA	8 V	
	TIG	8 V	
	MIG/MAG	8 V	
Rated HF peak voltage (U_p)	10.8 kV		
	Arc striking device designed to work with manual guided torch.		

Spare Parts

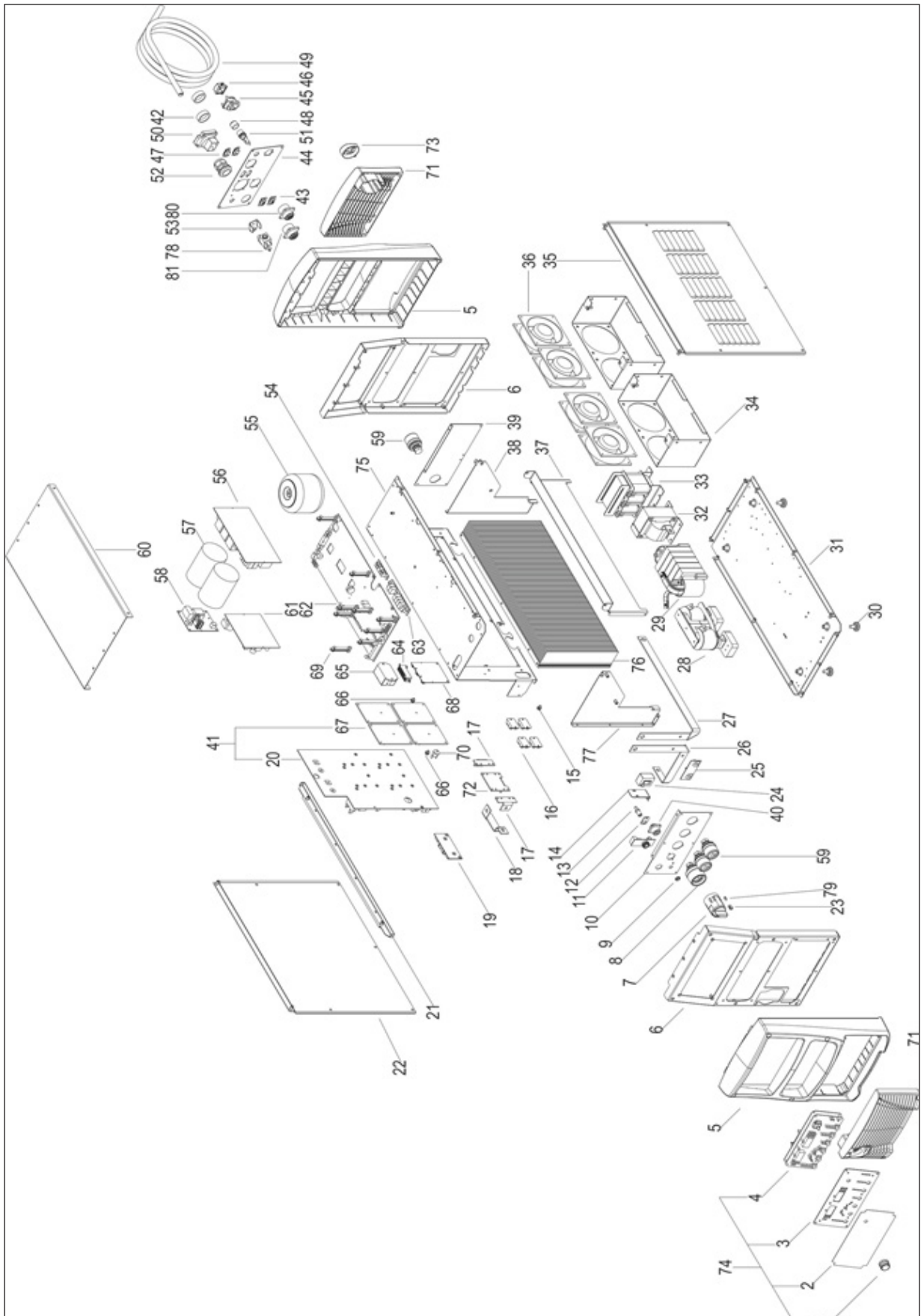

No.	order number	description
1	0835 27 41 00	KNOB WITH CAP
2	0835 27 41 01	FRONT PANEL LABEL
3	0835 27 41 02	LOGIC BOARD PLATE
4	0835 27 41 03	LOGIC BOARD
5	0835 27 41 04	COMPLETE FRONT LOGIC PANEL
6	0835 27 41 05	FRONT/REAR PLASTIC PANEL
7	0835 27 41 06	FRONT/REAR PLATE
8	0835 27 41 07	THREE-POLE SWITCH
9	0835 27 41 08	HIGH ISOLATION OUTPUT SOCKET
10	0835 27 41 09	FRONT SOCKETS PLATE
11	0835 21 00 13	AMPHENOL CONNECTOR BOARD
12	0835 27 41 10	SOLENOID VALVE BLOCK
13	0831 93 00 29	COMPLETE SOLENOID VALVE
14	0835 27 41 11	HALL SUPPORT PLATE
15	0835 23 00 06	THERMAL CUT-OUT
16	0835 27 41 12	ISOTOP DIODE
17	0835 27 41 13	INVERSION MODULE + BOARD
18	0835 27 41 14	DIODES-TRANSFORMER COPPER BRACKET
19	0835 27 41 15	ISOTOP/SOCKET COPPER BRACKET
20	0835 27 41 16	ISOTOP/DC + COOPER BRACKET
21	0835 27 41 17	SNUBBER BOARD
22	0835 27 41 18	INVERSION MODULE COOPER BRACKET
23	0835 27 41 19	COVER PANEL SUPPORT PLATE
24	0835 27 41 20	LEFT COVER PANEL
25	0835 27 41 21	POWER BOARD
26	0835 27 41 22	LED WIRING
27	0835 27 41 23	LED HOLDER
28	0835 27 41 24	TERMAL SWITCH L=130mm
29	0835 21 00 04	TERMAL SWITCH L=200mm
30	0831 93 00 36	POWER SUPPLY CONTROL BOARD
31	0835 27 41 25	OUTPUT FILTER BOARD
32	0835 27 41 26	RESISTOR
33	0835 27 41 27	THREE PHASE RECTIFIER BRIDGE
34	0835 21 00 40	BOARDS SUPPORT GUIDE
35	0835 27 41 28	BUS BOARD
36	0835 27 41 29	SUPPLIES BOARD
37	0835 27 41 30	HF BOARD
38	0835 27 41 31	UPPER COVER
39	0835 27 41 32	CAPACITOR
40	0835 27 41 33	MAINS FILTER BOARD
41	0835 27 41 34	AUXILIARY TRANSFORMER
42	0835 27 41 35	FAN AND C.U. CONTROL BOARD
43	0835 27 41 36	UPPER PLATE
44	0835 27 41 37	OUTPUT SOCKET
45	0835 27 41 38	RIGHT TUNNEL SUPP. PLATE

No.	order number	description
46	0835 27 41 39	VENTILATION SHROUD
47	0835 27 41 40	REAR PLATE
48	0835 27 41 41	REMOTE WIRING (COM2)
49	0835 21 00 37	SOLENOID VALVE PLATE
50	0835 27 41 42	REMOTE WIRING (COM1)
51	0835 27 41 43	CABLE CLAMP
52	0835 27 41 44	RS-232 CONNECTOR CAP
53	0835 27 41 45	SOCKET FOR HEATER
54	0835 27 41 46	REMOTE CONNECTOR CAP
55	0835 27 41 47	SUPPLY CABLE
56	0835 21 00 34	ILME CONNECTOR CAP
57	0835 27 41 48	C.U. POWER SUPPLY WIRING
58	0835 27 41 49	FUSE HOLDER CAP
59	0831 93 00 31	FUSE HOLDER
60	0835 27 41 50	REAR PANEL
61	0835 27 41 51	RS-232 CABLE
62	0835 27 41 52	CAP
63	0835 27 41 53	PLASTIC LOUVRE
64	0835 27 41 54	FAN
65	0835 27 41 55	RIGHT COVER PANEL
66	0835 27 41 56	INTERNAL FAN SUPPORT
67	0835 27 41 57	OUTPUT INDUCTOR
68	0835 27 41 58	OUTPUT INDUCTOR
69	0835 27 41 59	LOWER COVER
70	0835 21 00 15	RUBBER FOOT
71	0835 27 41 60	POWER TRANSFORMER
72	0835 27 41 61	HEAT SINK
73	0835 27 41 62	LEFT TUNNEL SUPP. PLATE
74	0835 27 41 63	HF COIL
75	0835 27 41 64	(+) SOCKET COPPER BRACKET
76	0835 27 41 65	(-) SOCKET COPPER BRACKET
77	0835 27 41 66	OUTPUT FILTER BOARD
78	0835 27 41 67	HALL EFFECT SENSOR
79	0835 27 41 68	REMOTE LOGIC CABLE

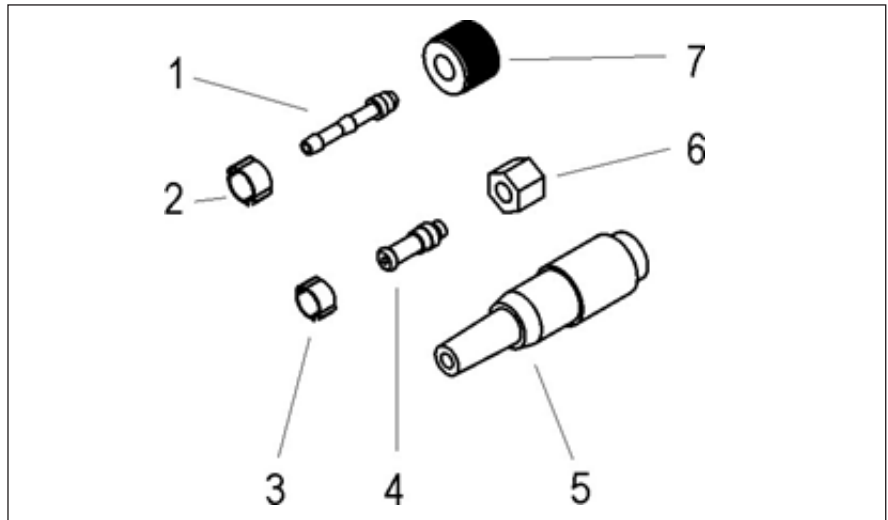

No.	order number	description
	0835 21 00 12	TORCH CONNECTORS COMPLETE KIT
1	0835 21 00 43	SLEEVE HOSE ADAPTER FOR RUBBER HOSE 1/4
2	0835 21 00 44	HOSE CLAMP $\varnothing=11-13$
3	0835 21 00 45	HOSE CLAMP $\varnothing=07-09$
4	0835 21 00 46	SLEEVE HOSE ADAPTER FOR RUBBER HOSE M10
5	0835 21 00 47	AMPHT3360-001 M/5V. VOL. CONNECTOR
6	0835 21 00 48	NUT M10
7	0835 21 00 49	NUT 1/4

ELECTRICAL DIAGRAM GL 502

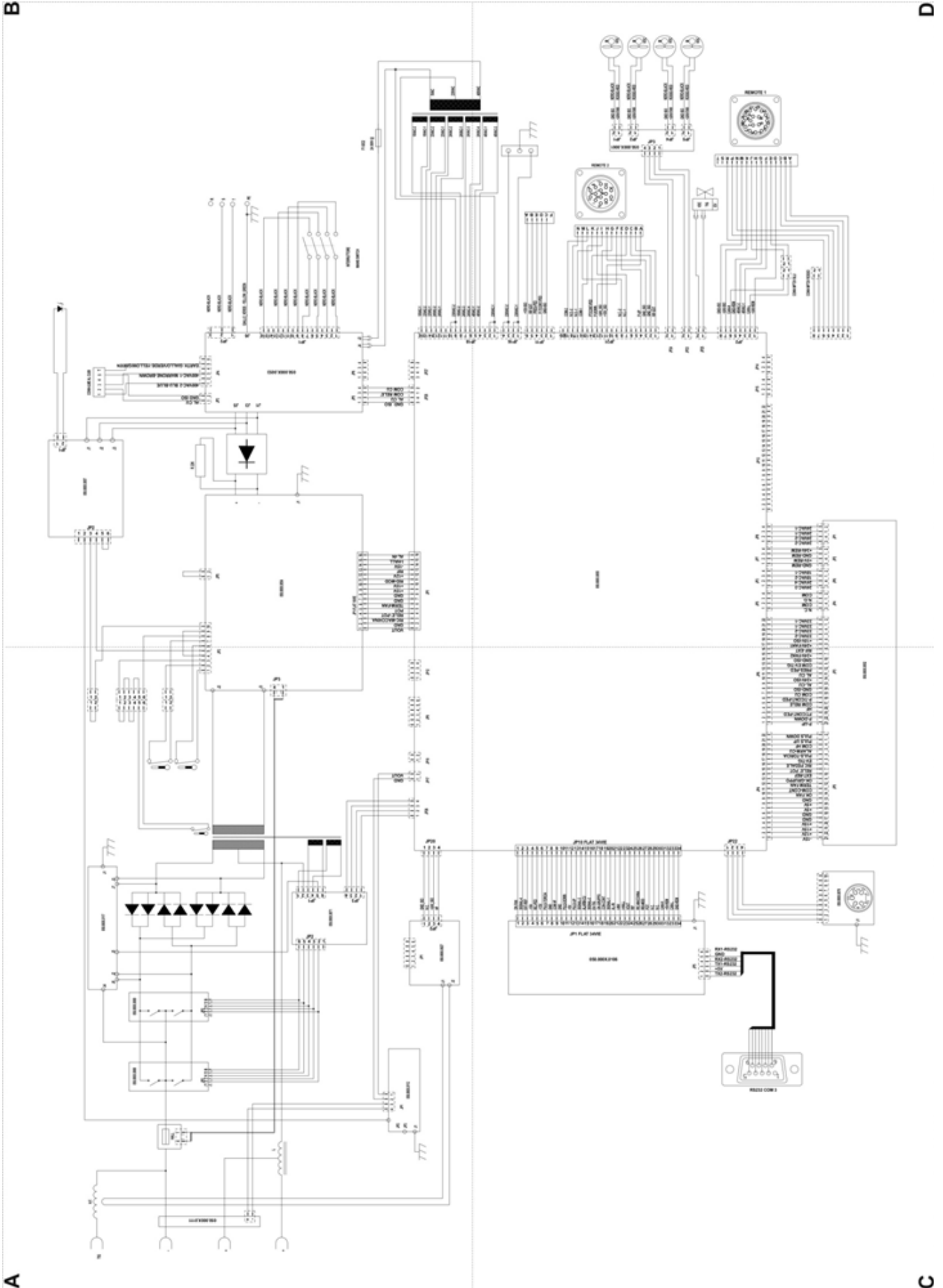

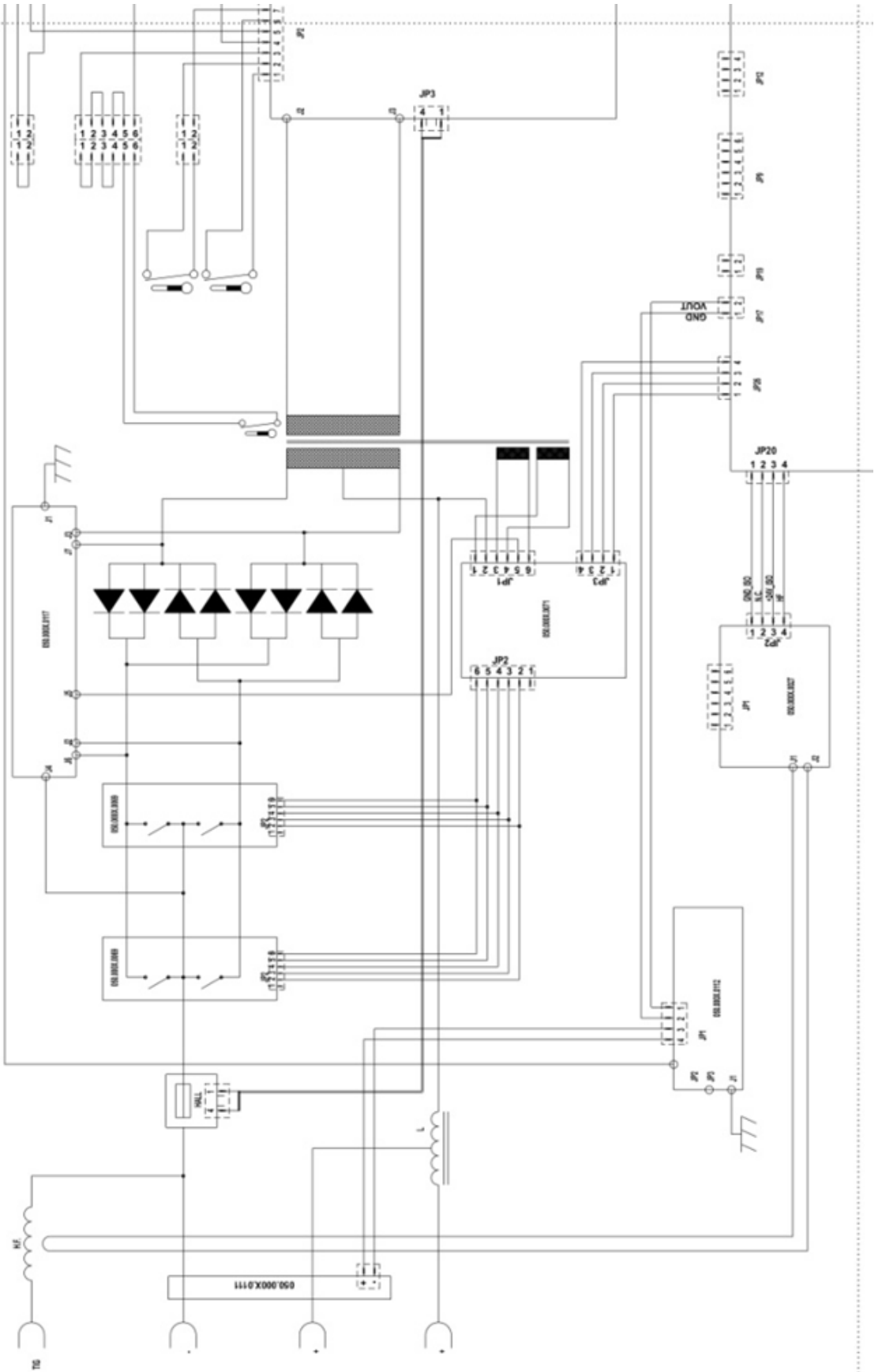

A

B

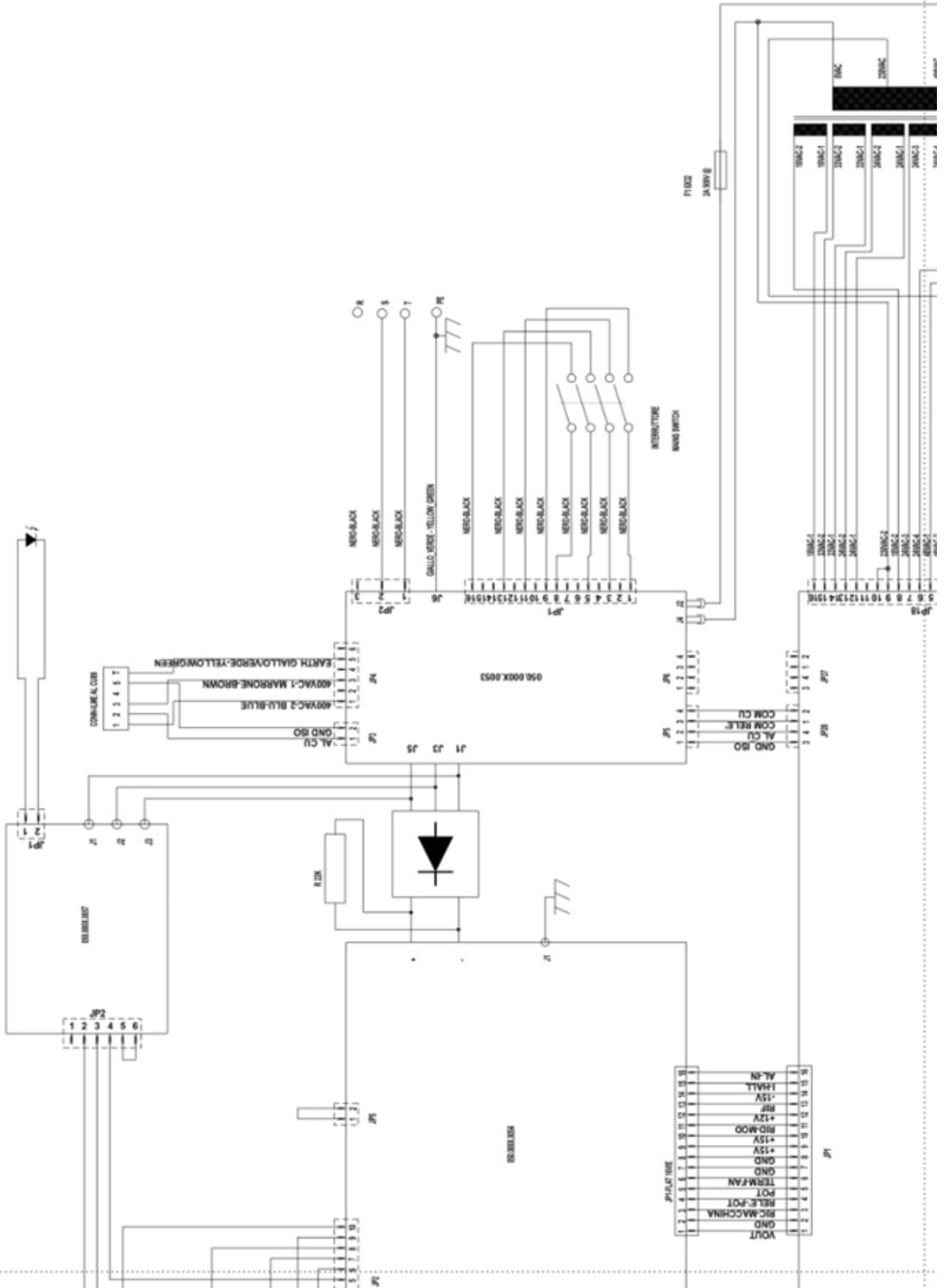

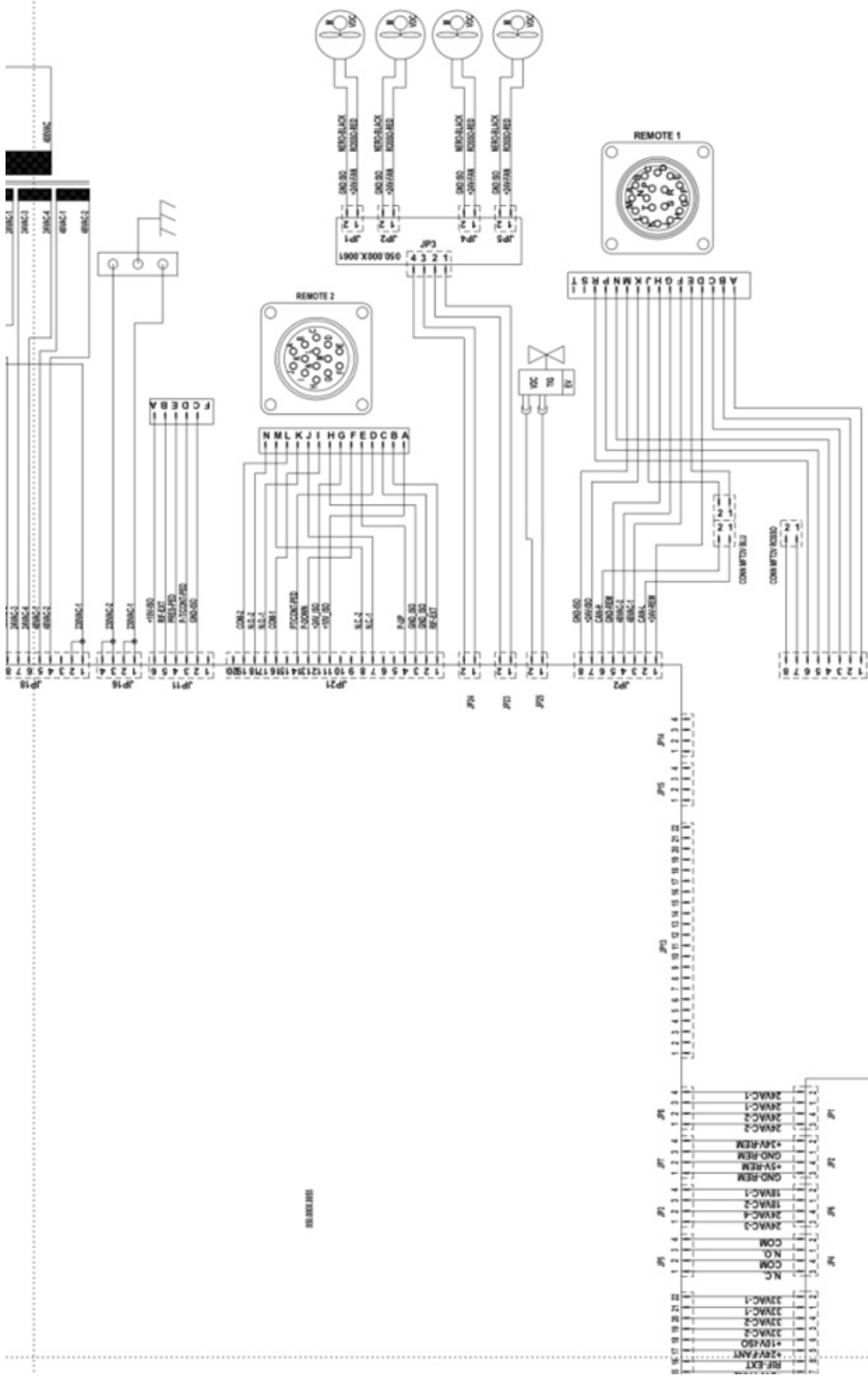

12.1 CONNECTOR FOR "REMOTE 1"

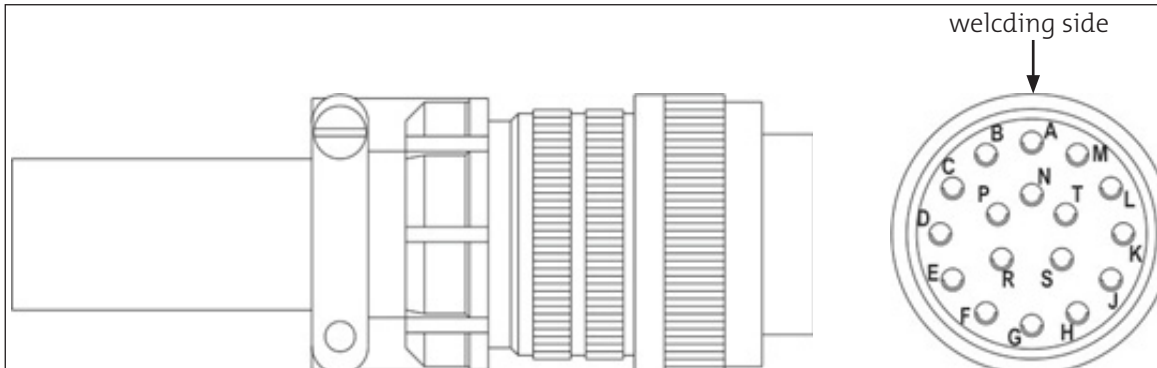

12.2 CONNECTOR FOR "REMOTE 2"

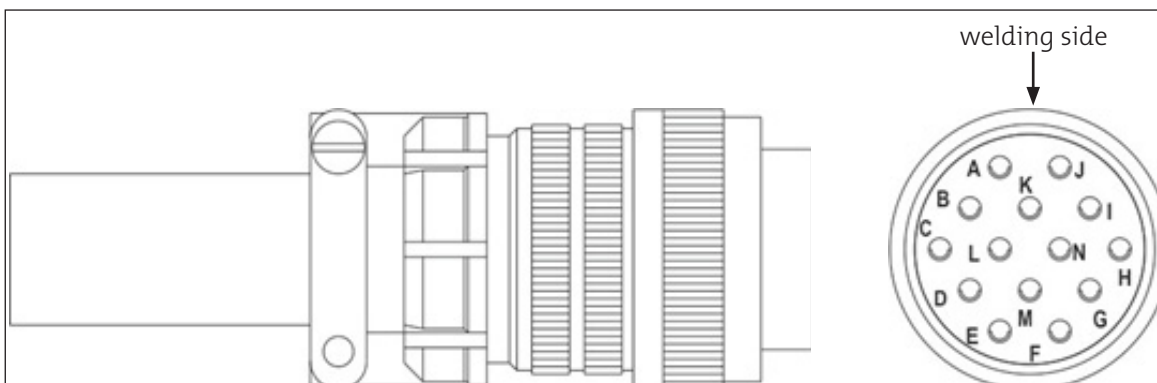

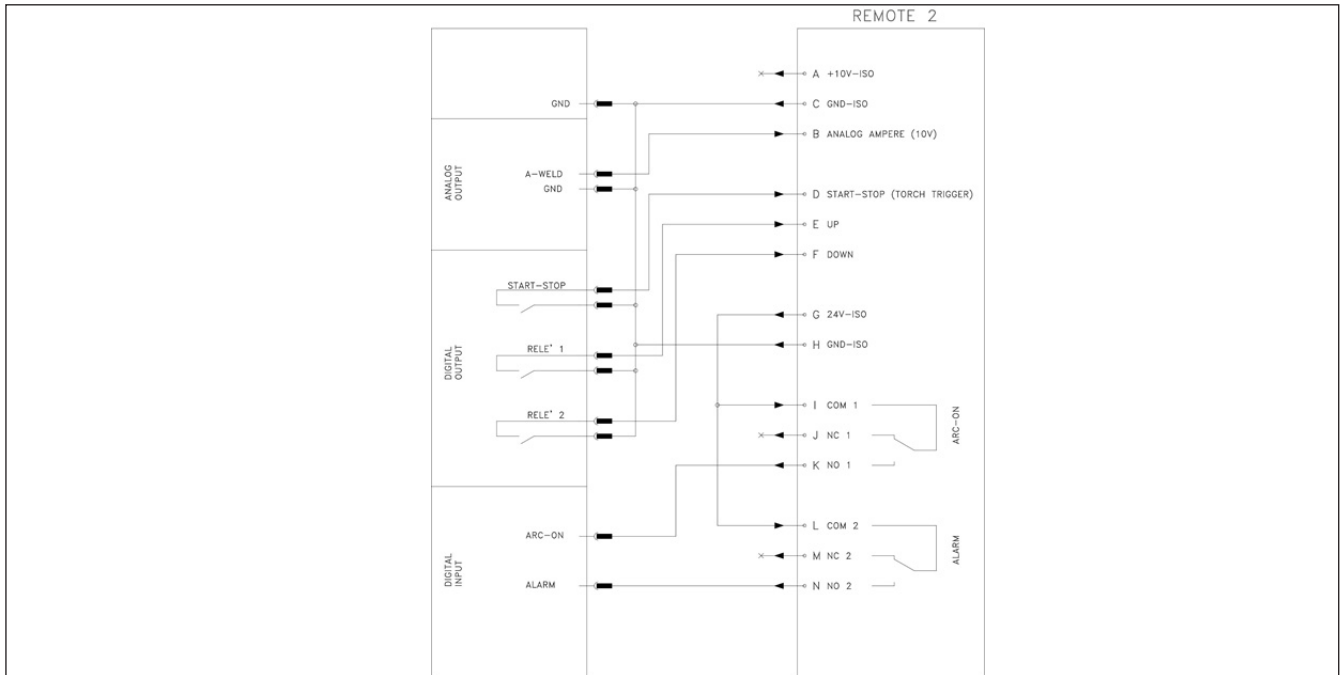

LEGEND: = output signal coming out of RC
 = input signal going into RC.

Pin	IN / OUT	Signal	FUNCTION	NOTES
A		+10 V-ISO	Insulated 10 Volt	-
B		ANALOG AMPERE (10 V)	AMPERE CONTROL: it communicates the welding current with an analogical signal of between 0 V and +10 V.	Analogue signal 0- (+10 V)
C		GND ISO	Insulated ground	-
D		START-STOP (TORCH TRIGGER)	TORCH KEY: the command for passing from one welding time to another.	0 V (welding time change) floating (no variation)
E		UP	JOBS UP Upward selection of jobs	floating (no variation)
F		DOWN	JOBS DOWN Downward selection of jobs.	+5 V Scroll down through jobs
G		+24 V-ISO	Insulated 24 Volt	-
H		GND ISO	Insulated ground	-
I		COM 1	-	-
J		NC 1	-	-
K		NO 1	ARC IGNITED SIGNALLING: function that signals that the arc has started and that the welding process is underway.	+24 V (output power active) 0 V (output power de-activated)
L		COM 2	-	-
M		NC 2	-	-
N		NO 2	ALARM TRIGGERED WARNING: function that points out that any one of the alarms of the equipment has triggered.	+24 V (output power active) 0 V (output power de-activated)

TORCH CONNECTOR

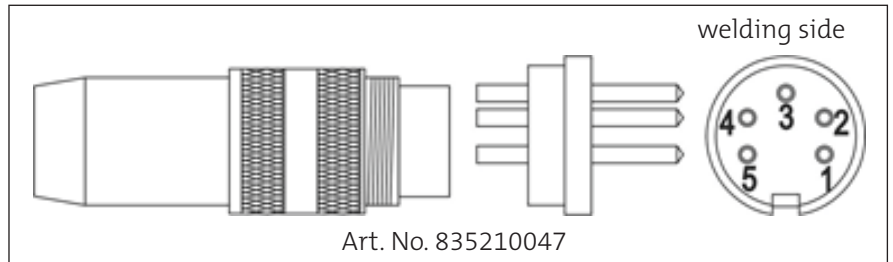

- Torch

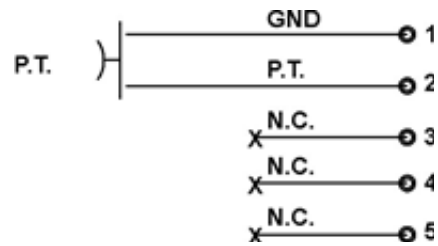

- Up & Down-Torch

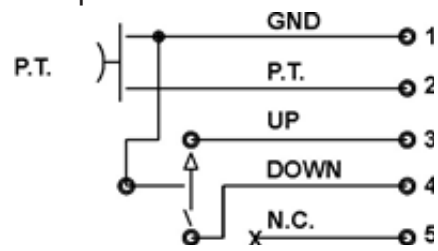

REMOTE CONTROLLER CONNECTOR

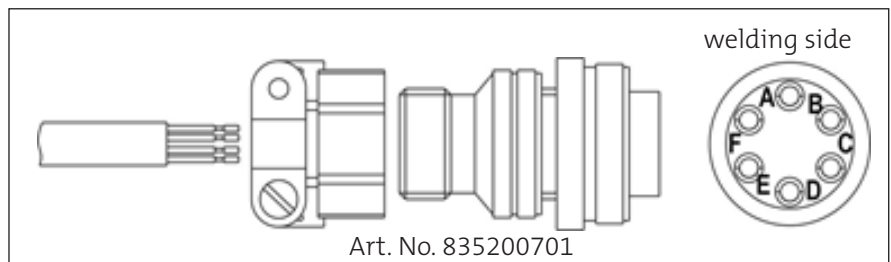

- Torch with potentiometer

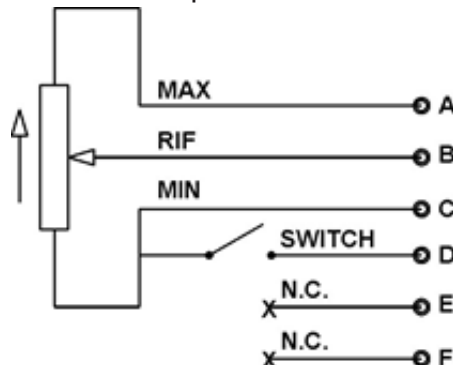

Potentiometer 2 k Ω -10 k Ω

- Remote Controller

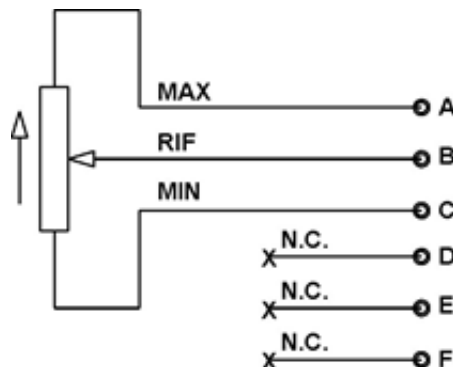

Potentiometer 2 k Ω -10 k Ω

- Foot pedal controller

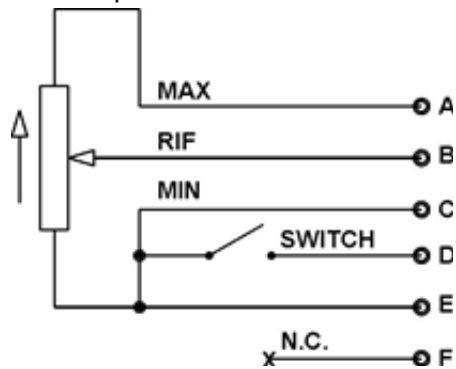

Potentiometer 2 k Ω -10 k Ω

CLOOS

Weld your way.